

TOWER FARMS

## 31st ANNUAL STAG AND HIND SALE



**Bandit @ 3yrs - 600 5/8 IOA - owned by Crowley Deer**

**Saturday 14th December 2019 at 5.00pm**  
**188 Discombe Road, Hautapu, Cambridge**

# DIRECTIONS TO TOWER FARMS SALE VENUE

LOCATED AT 188 DISCOMBE ROAD, HAUTAPU

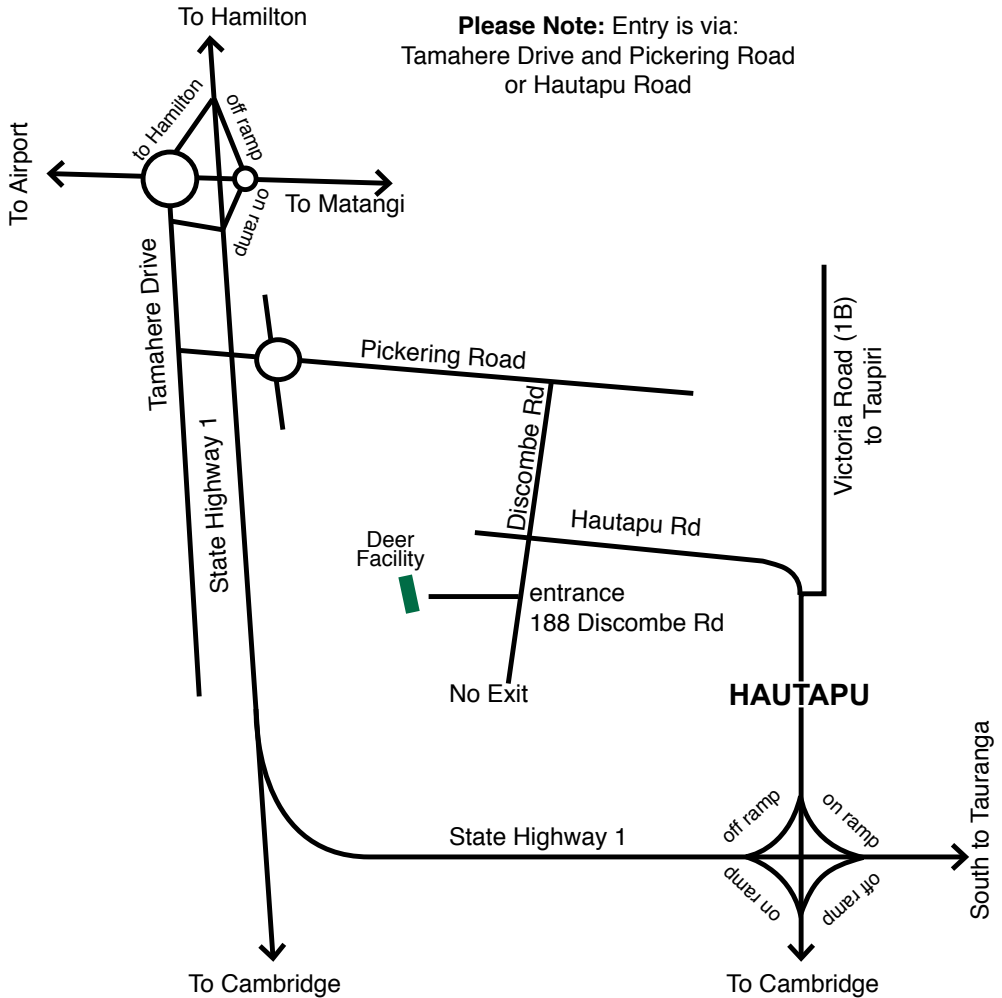

## Enquiries

joe@towerfarms.net

07 823 3309

Joe Crowley 0274 727 436

Sue Douglas 027 281 8721



TOWER FARMS

## Conditions of Sale

1. The sale will be conducted by Neville Clarke under the auspices of the New Zealand Stock and Station Agents Association according to their usual terms and conditions.
2. As is customary all purchases will be **the buyers property and risk from the fall of the hammer**. Tower Farms takes all care but no responsibility for deer held prior to transporting to the purchaser, **we recommend you insure your purchase**.
3. Deer will be sold under individual Lot numbers as catalogued.
4. No deer are to leave the property until satisfactory payment arrangements have been made with the vendor.
5. The sale will be conducted exclusive of GST.
6. **Disclaimer:** All details in this catalogue have been supplied to the Auctioneer by the vendor and although every care has been taken to ensure accuracy, the auctioneer and their employees do not accept any responsibility or liability as to mis-description, errors, omissions or mis-statements caused either directly or by the negligence of the auctioneer or their employees.
7. An over riding commission of 4% will be paid to non participating companies providing **PRIOR ARRANGEMENTS** (i.e. No later than 24 hours prior to sale day) are made with Joe or Sue. **There are no exceptions to this rule!**
8. **No animals, embryos or semen sold by Tower Farms or their germ plasm, any subsequent progeny or germ plasm, including the semen and germ plasm of that progeny, may be supplied to any third party without the written permission of Tower Farms. This condition does not affect normal commercial deer farming or stud farming on their normal sales of semen or embryos as it only applies to entities with the primary function of commercial semen/germ plasm activity.**
9. We encourage stag purchasers to transport their stags with antlers on (transporters specialize in this). Hard Antler removal later will circumvent the risk of, for which we are not responsible, pedicle skin die back. **Unless we are advised that stags are to leave Tower Farms with their antlers on, the velvet will be removed the day after the sale, and retained by Tower Farms. All animals are to be transported before Christmas.** Note Sue Douglas will organise all transport.
10. Should a stag prove to be infertile from natural causes it will be replaced or a full credit given to use at a subsequent Tower Farms Deer Stag Sale, in this situation the stag in question is to be returned to the vendor. In all events the seller will not be held responsible for loss of production or consequential losses on any animal sold. Notification of any dissatisfaction must be made within 9 months of the date of sale. Subject to these terms, the vendor makes no warranty about any animals sold. **We recommend that a back up sire be used especially in the first year of a young stags use.**

**PLEASE ENSURE THAT ALL DOCKETS ARE SIGNED GIVING EXPLICIT DEVELVETING, TRANSPORT AND ANY INSURANCE INSTRUCTIONS TO ADMIN, SUE DOUGLAS BEFORE LEAVING THE SALE**

### **Insurance**

Livestock insurance will be available on the day.

### **T.B Status**

The property is T.B Accredited.

The last test being performed 30th July 2017 No. 355 1197 C10



TOWER FARMS

**Sale Day Auctioneer:** Neville Clarke

Sales enquiries to “ANY” Deer Specialist NZ wide

**North Island contacts:**

Keith Burden 027 5975801  
Hawkes Bay

Sam Wright 027 4430905  
Rotorua

Barry MacIntosh 027 4721974  
Waikato

Bob Dunn 027 4948716  
Hamilton

Noel Cudby 027 4444620  
Kapiti

**South Island contacts:**

Graeme Kinsman 027 4223154

Alf Kinzett - CRT Livestock 027 2418919

Adam Whaanga 027 4183438

Ben Beadle 027 728 1052

Craig North 027 473 0864

Or contact your own Deer agent

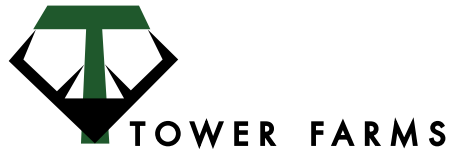

# Sire References

# Sire Reference



## Bandit



**12 229**

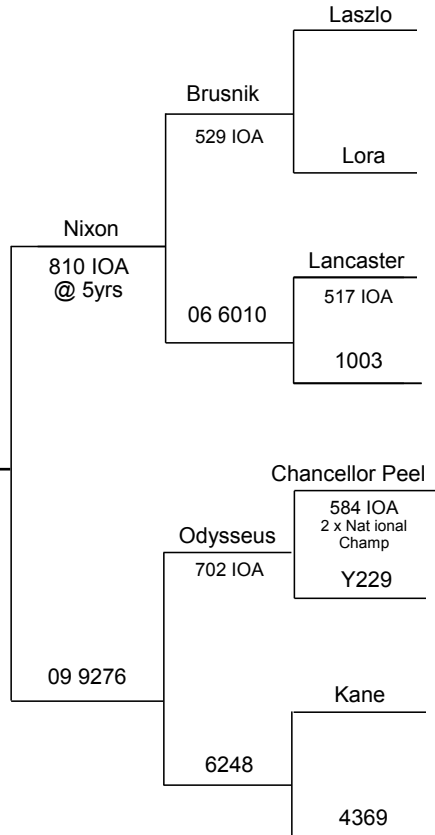

Age	Year	Live Weight	Hard Antler	Velvet
2 yr	2014	175kg	421 IOA	
3yr	2015	225kg	600 5/8, 54pts 4th Rising Stars 3yr HA	
4yr	2016		670 IOA	

Bandit is an outstanding Nixon son from Todd's "back paddock". He is one of two Nixon sons to score 600+ IOA at 3yrs, and is the 7th son from Nixon's total stag fawn drop in 2012, the other six brothers were all outstanding sale stags with the crème de la crème making \$128,000. These stats and consistency are unmatched by any other stag on the planet. Leased from Crowley Deer for the April 2016 mating season.

# Sire Reference



## Beauden



**13 325**

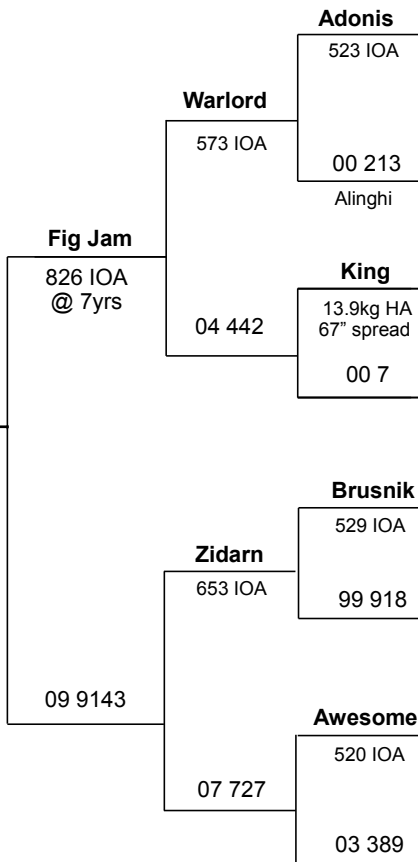

Age	Year	Live Weight	Hard Antler	Velvet
3 yr	2016		37pts	9.4kgs (June)
5 yr	2018		Not Measured	



Trophy "Caviar" in the look of Beaudens 3yr antler, everything we want in our signature trophies, perfectly clean bottom tynes, (yielding SAP trophy velvet) exceptional spread, and good clean multi tops.

# Sire Reference



## Fig Jam



**08-8067**

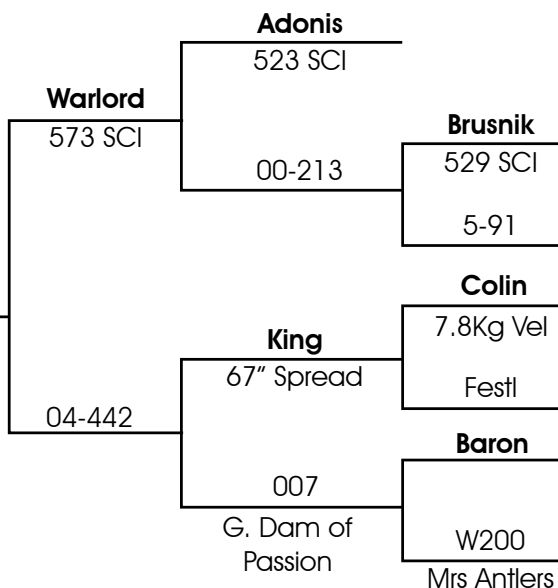

Age	Year	Live Weight	Hard Antler / SCI
1 yr	2009		44" Spread
2 yr	2010		352
3 yr	2011		466 7/8"
4 yr	2012		560 4/8" IOA
5 yr	2013		60+ points
6yr	2014		636 IOA
7yr	2015		826 IOA (Retired)



Exceptional trophy stag in antler (clean bottom tynes (for velvet) very very wide spread, multi pointed tops). Fig Jams PASS ON RATE in his male offspring of his own attributes is PHENOMALLY high.



# Sire Reference



## Grafanarkis



**09 9208**

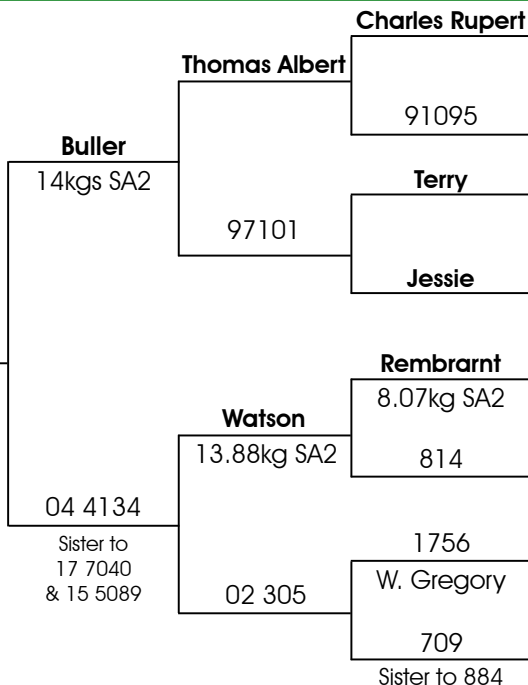

Age	Year	Hard Antler	Velvet
4 yr	2013	1st N.I.V.C & National Velvet Champ, 4yr section	8.4kg SAP
5 yr	2014	1st N.I.V.C Open Section, N.I.V.C. Peoples Choice Award, 2nd 5yr section Nat Vel Comp.	9.05kg SAP
6yr	2015	2nd NIVC Open Section, 1st Rising Stars - Super Heavy Weight Peoples Choice Award	11.1kg SAP
7yr	2016	3rd NIVC Open Section	10.37kg SAP
8yr	2017	3rd NIVC Open Section	12.41kg SA <sub>2</sub>
9yr	2018		12.2kg SA <sub>2</sub>
10yr	2019		10.35kg SA <sub>2</sub>



Exceptional velvet weight, style and round beam length in Grafanarkis' velvet. From a total fawn drop of 22 stags in 2015, Grafanarkis had ten 3yr sons in the December 2018 Stag Sale ranging from 6.3kgs to 9.65kgs, averaging 7.31kgs.

# Sire Reference



## Klein



**13 3006 @ 4yrs**

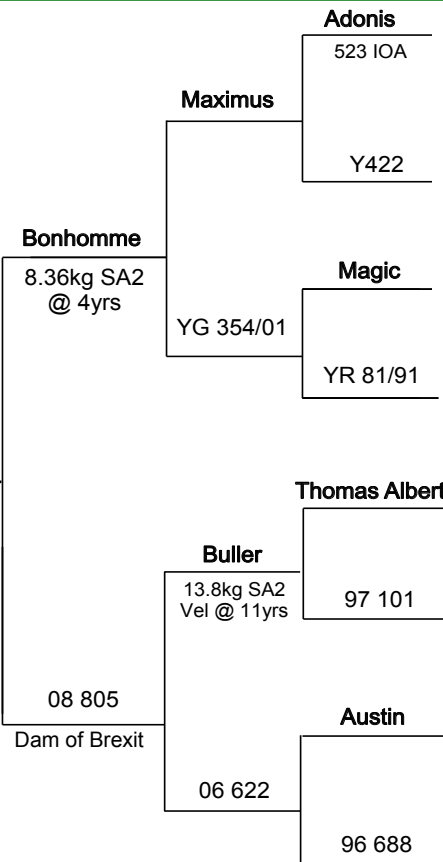

Age	Year	Live Weight	Hard Antler	Velvet
2 yr	2015			5.3kgs OG1/OG2
3 yr	2016			3.05kgs SA2 velvet one side
4yr	2017			7.6kgs SA <sub>2</sub>

Exceptional temperament and velvet beam size at 2yrs of age (18/19, 20/19) with style similar to Bonhomme and Grafanarkis. Klein had a protracted left rear hoof infection through August and September 2016 which may have been responsible for an unorthodox beam shape in one stick of his velvet.

# Sire Reference



## Parker



**08 8127**

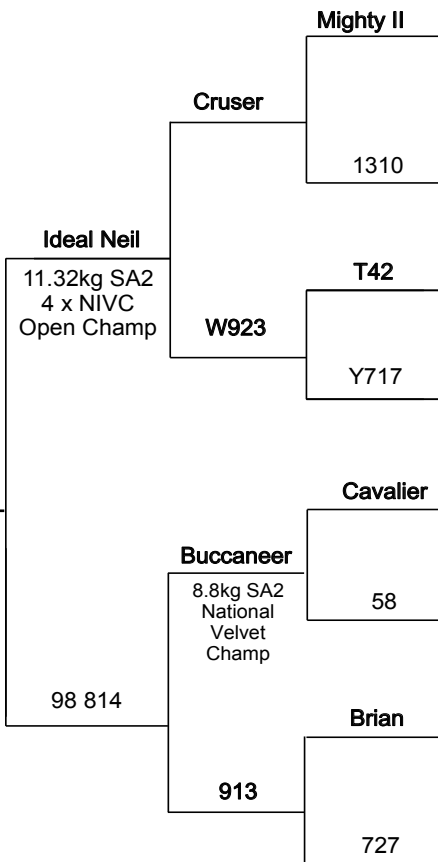

Age	Year	Live Weight	Hard Antler	Velvet
7 yr	2015			8.3kgs SAP
8yr	2016			11.75kg SA2
9yr	2017		15.25kg HA	

Parker was a twin out of Watsons dam 98 814. He was sent to the commercial block because as you would expect from a twin he didn't make the minimum sale weight at 2 years. However with time his body weight has caught up and his velvet is a mirror image of his sire Ideal Neil. Given our velvet breeding focus of weight with length and style" Parker is a worthy team member in our sire group. "Personality plus" is our Parker, he regularly camps on his own near the smoko room and talks to you, but conversely he will give a shadow a hell of a thrashing during the roar.

# Sire Reference



## The Pentagon



**The Pentagon**  
**14 4024**  
**@ 3yrs**

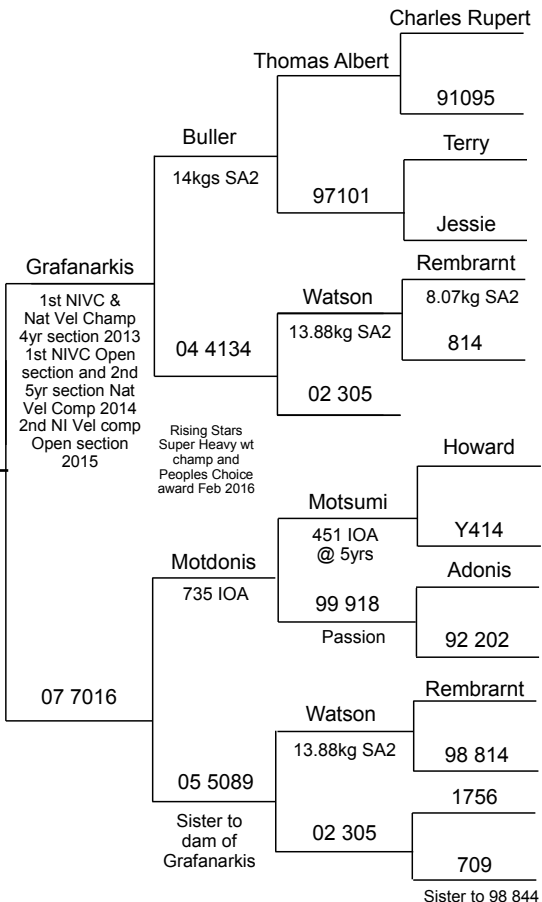

Age	Year	Live Weight	Hard Antler	Velvet
2 yr	2016			4.3kg SA2
3 yr	2017			7.21kg SAP
4 yr	2018			10kg SAP
5 yr	2019			11kg SA2

The Pentagon cut 10kg SAP velvet 2018. Of special note The Pentagons grand dam 05 5089 is also the dam of JD.

# Sire Reference



15 5033

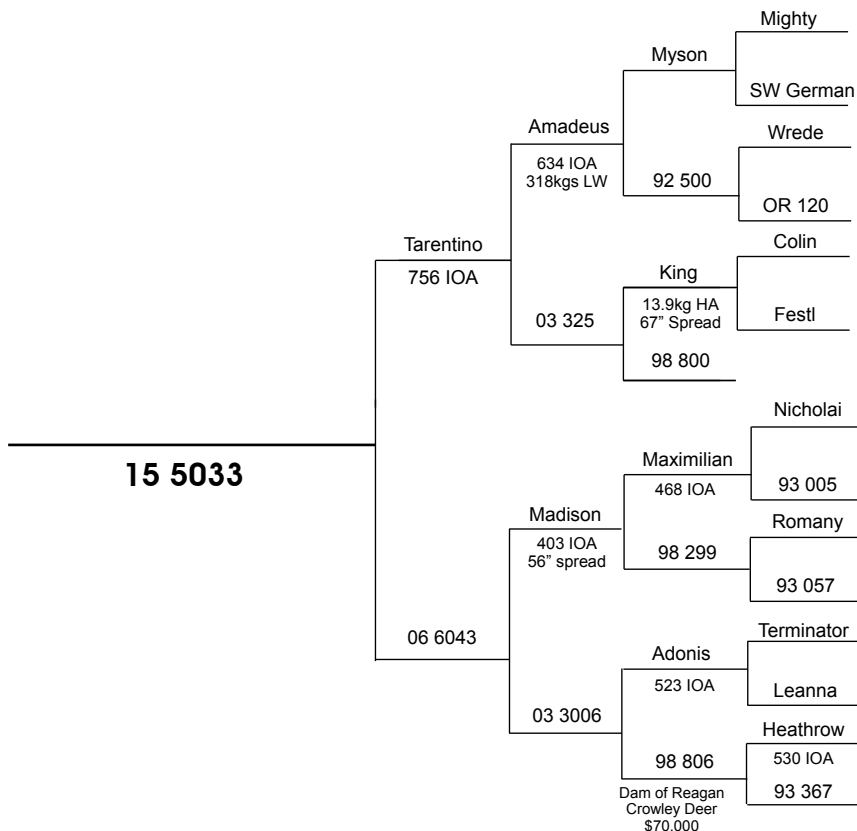

Age	Year	Live Weight	Hard Antler	Velvet
2 yr	2017			4.25kg
3 yr	2018		Grown Out	
4yr	2019			7.05kg SA2

We used 15 5033 as a back up to Jefferson in April when Jefferson got a balanitis, and was removed on the 12th from his mating mob (only six out of 40+ unmated). Dam 06 6043 is an exceptional Madison daughter who passes on her bomb proof temperament and high superior antler strike rate in her offspring. 15 5033 was huge at 2yrs and cut 4.25kgs SAP style velvet with beam of 19/18 and 20/18. 6043 has left us six sire stags now, the most outstanding by Holy Oak who is currently No 2 in the SCI record book.



Sale Weight: \_\_\_\_\_  
 Purchaser: \_\_\_\_\_  
 Price: \_\_\_\_\_

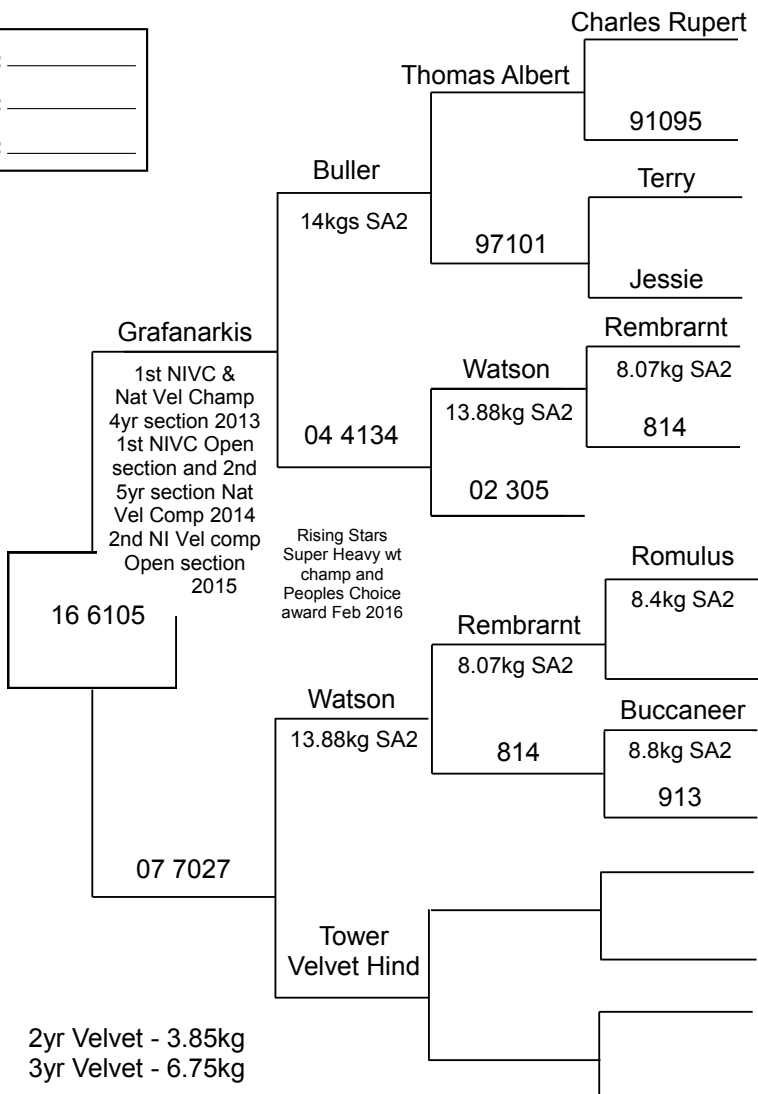

A very even and tidy head of velvet in place for 16 6105. Comments at removal were, heavy long and strong brows, good medium bezs, two basals, good length trezs, and top tyne placement, the beam above the trezs is taking on a trumpet shape.





Sale Weight: _____
Purchaser: _____
Price: _____

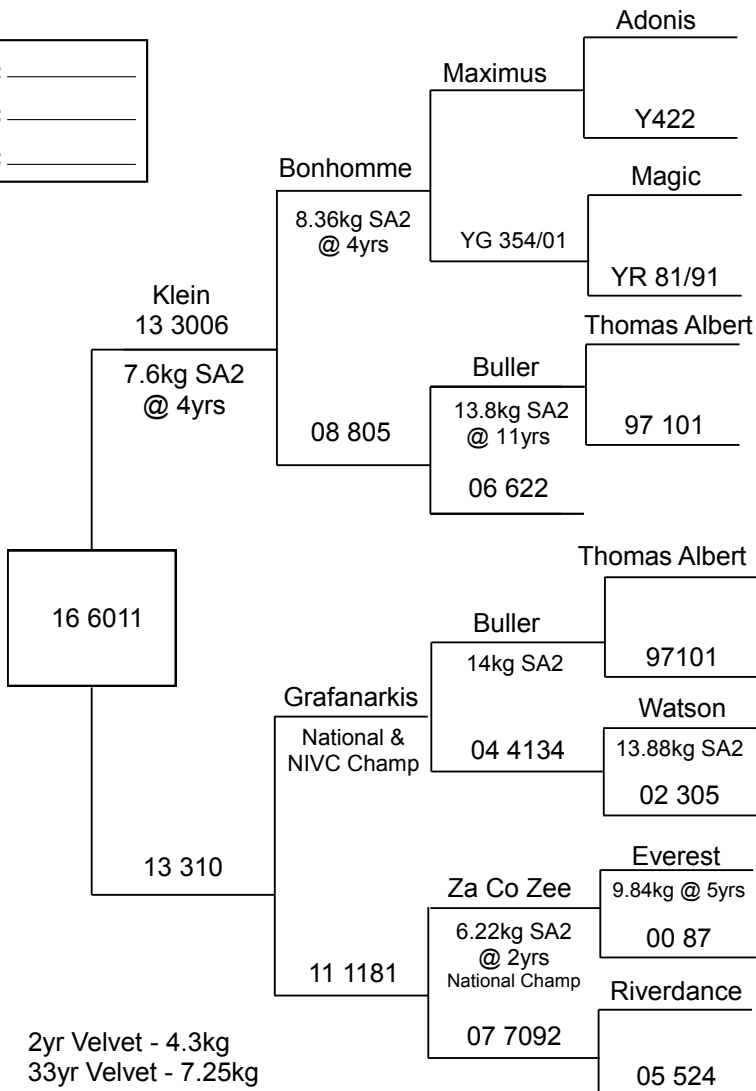

One of the first crosses to come to auction with Grafanarkis on the bottom line. Removal comments were big, strong, straight brows, both bezs higher, thick trezs, left bifurcating, way long beam, cut early at 16 and 17cm above the trez. Beam stats of 23/23 and 23/23.

**Lot 4**
**R3yr Stag 16 6198**

Sale Weight: _____
Purchaser: _____
Price: _____

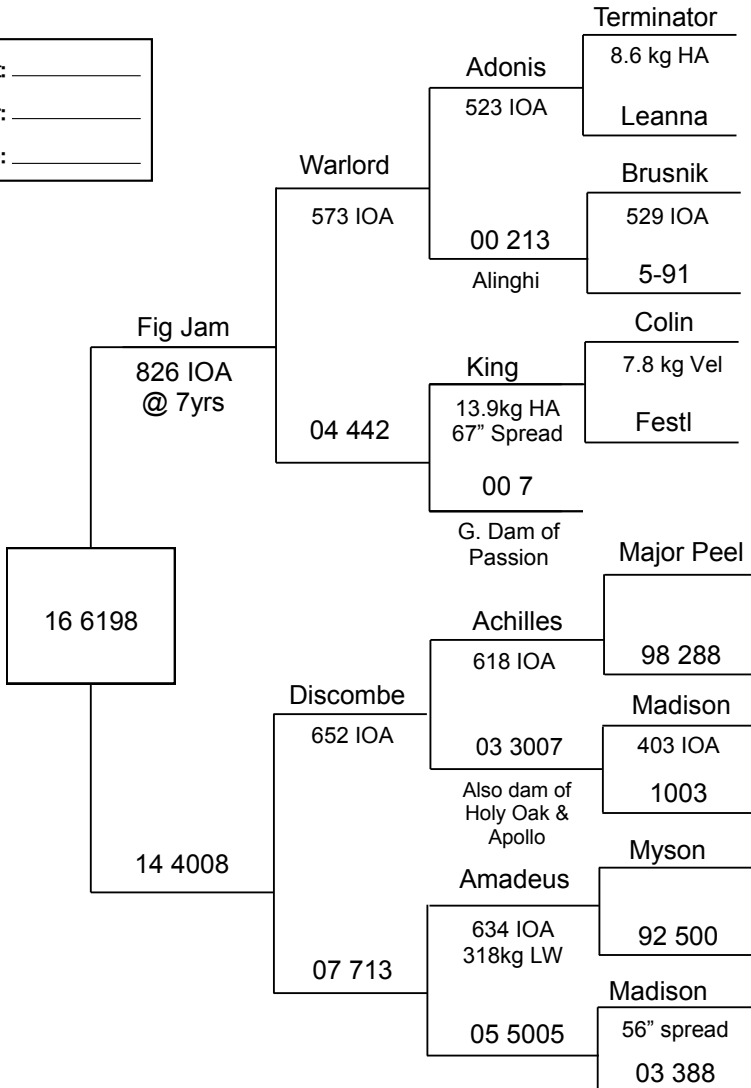

There is 26 lines of progeny data to choose from, in the bottom line, the most 'GLITZY' line is great grandam 05 5005 sold to Mt Cecil in 2015 for \$1100 producing Lennix (Rockvale) 1, 2, 3 and 4 year HA champion, for the last 3 years, 05 5005 is still being embryoed, to maybe produce another Lennix, who should he stay alive, may surpass his sires Leon found dead 929 SCI world record. 16 6198s head shows very long and strong brow, bez and trez at cutting stage. Promising.

Sale Weight: _____
Purchaser: _____
Price: _____

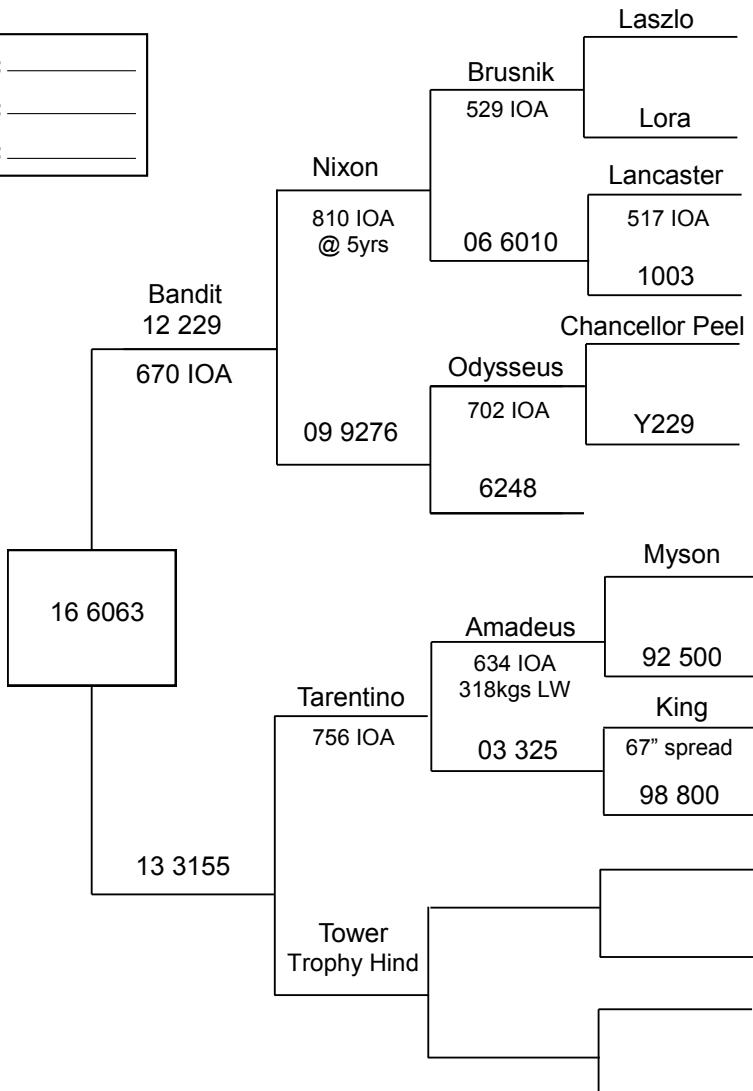

Stag 16 6063 is the only offspring from dam 13 3155 who is now owned by Criffel Park. While missing his grandams identification, like us with Rembrants missing mum, does it matter, if he leaves behind what he displays himself. Heavy brow, bez and trez, wide V shaped aspect, heavy long trezs, beam thickens dramatically to EXCEPTIONALLY large heavy bulb not yet burst.

**Lot 6**
**R5yr Stag 14 4024 The Pentagon**

Sale Weight: _____
Purchaser: _____
Price: _____

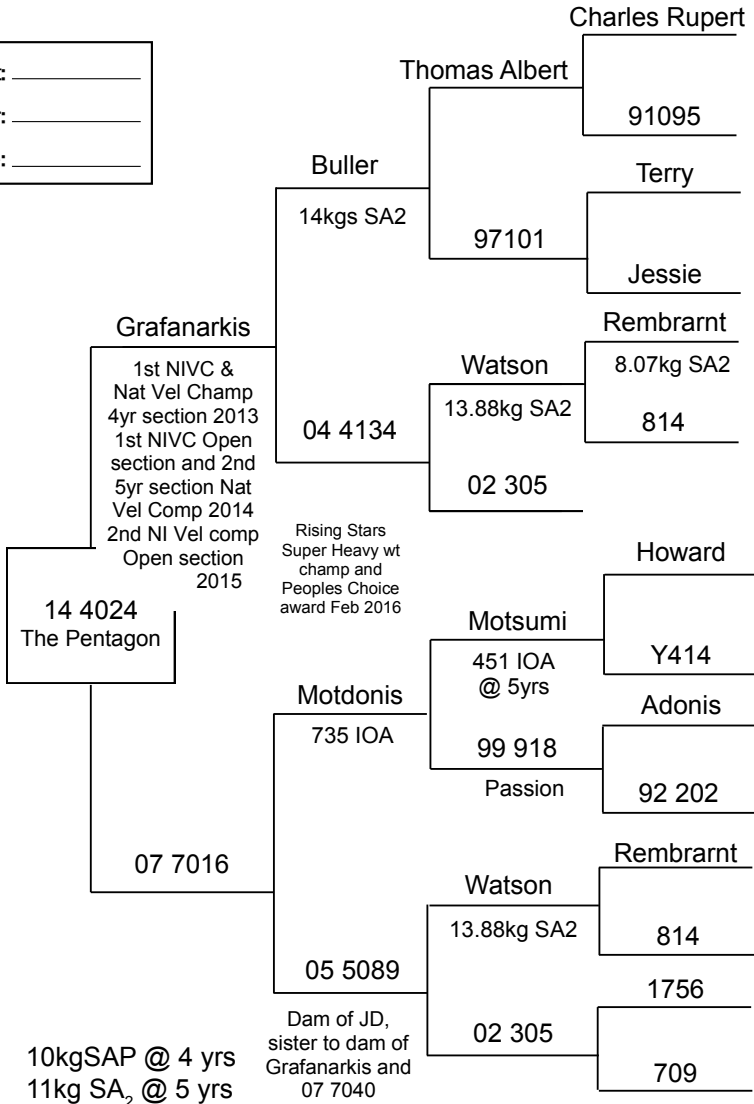

The Pentagon is a full brother to 3yr stag 16 685 who cut a perfect head of 6.9kg of SAP velvet this year, as was The Pentagons 3yr head of 7.21kg SAP velvet, placing him second in the NIVC 2017. The Pentagon comes from an illustrious hind base that had three 3yr stags sell last year for a total of \$175,000 cutting 9.85kg, 9.65kg and 8.5kgs of SAP velvet. While the dollars are always welcome, the MOST SIGNIFICANT factor is the HIGH STRIKE RATE and REPEATABILITY of this family.

Sale Weight: \_\_\_\_\_  
 Purchaser: \_\_\_\_\_  
 Price: \_\_\_\_\_

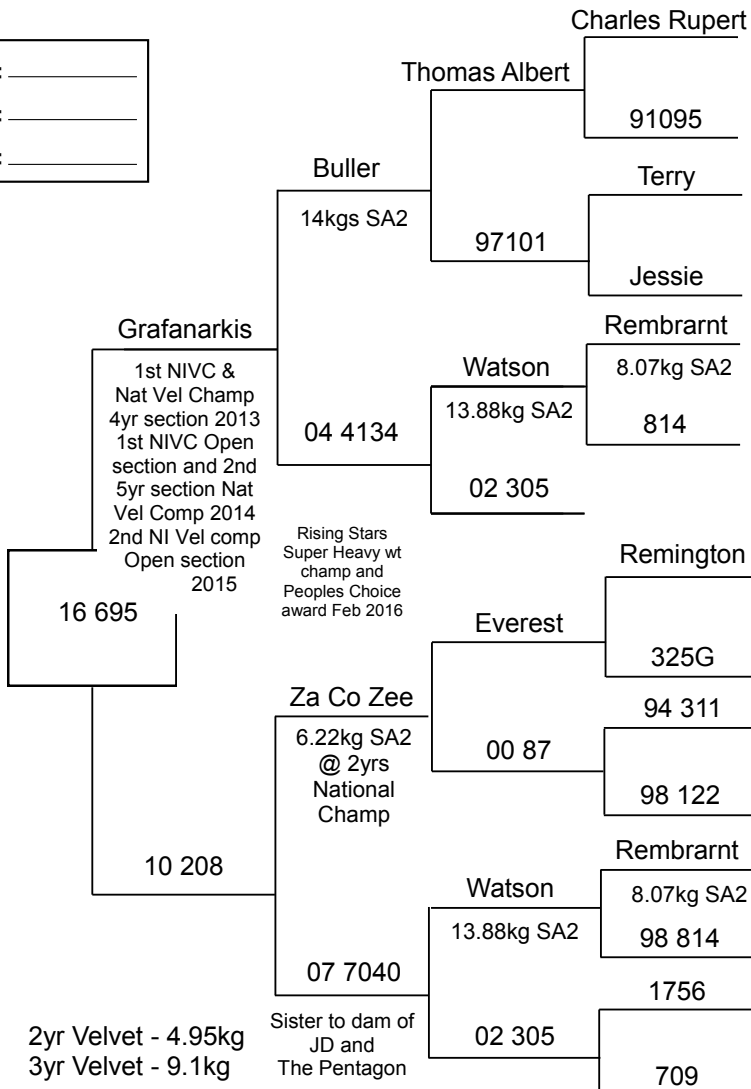

Exceptional progeny data here to support this stag. Dam 10 208 produced the top priced stag in our Dec 2015 stag sale cutting 6.9kg of velvet making \$28,000. 16 695 cut 4.95kg of velvet at 2yrs and hails from the bottom line family of 07 7040 (Grafanarkis' dams sister) who dominated our 2018 3yr velvet sire stags, Brax (15 5090) - 9.85kg \$45,000, 15 5131 - 8.5kg \$65,000, 15 5129 - 9.65kg \$65,000. 16 695 can be staunch on his own.

**Lot 8**
**R3yr Stag 16 690**

Sale Weight: _____
Purchaser: _____
Price: _____

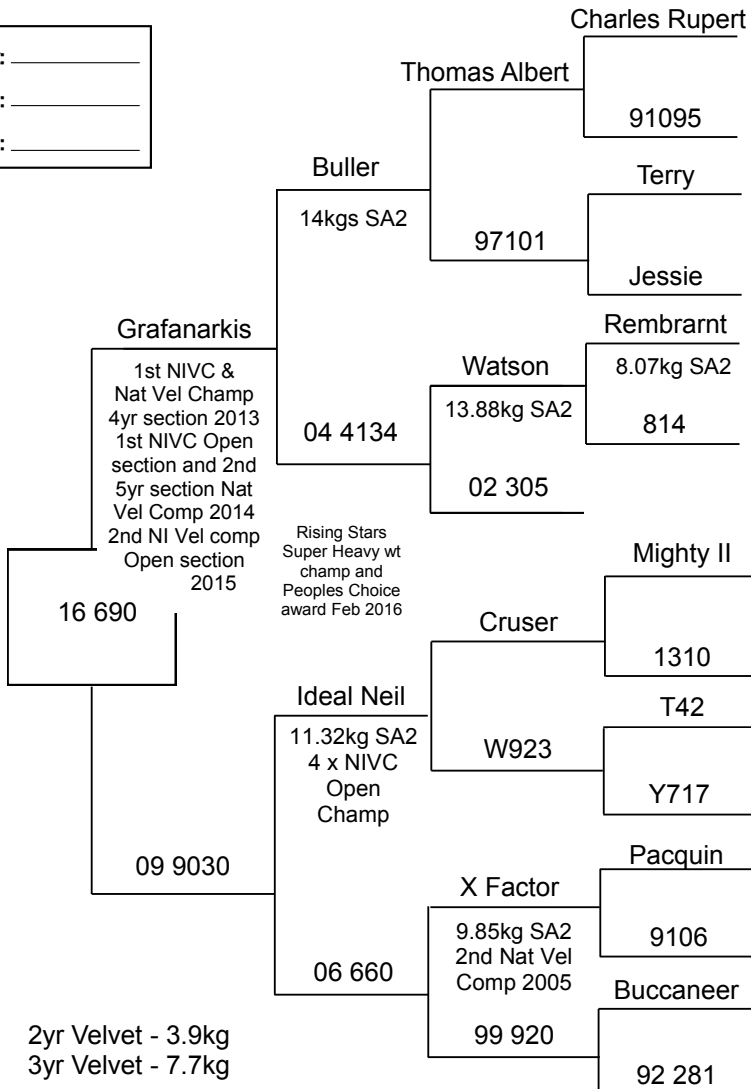

Stag 16 690 is the third son from dam 09 9030, her first son sold Dec 2017 for \$10,000 cutting 7kg of velvet. Great grandam 99 920 is the dam of 'Fats' that we sold to the late Brian Wellington and now used successfully at Ruperts in Geraldine. 16 690s average beam size is 24cm, we cut him at only 16 and 17cm above the trez.

Sale Weight: _____
Purchaser: _____
Price: _____

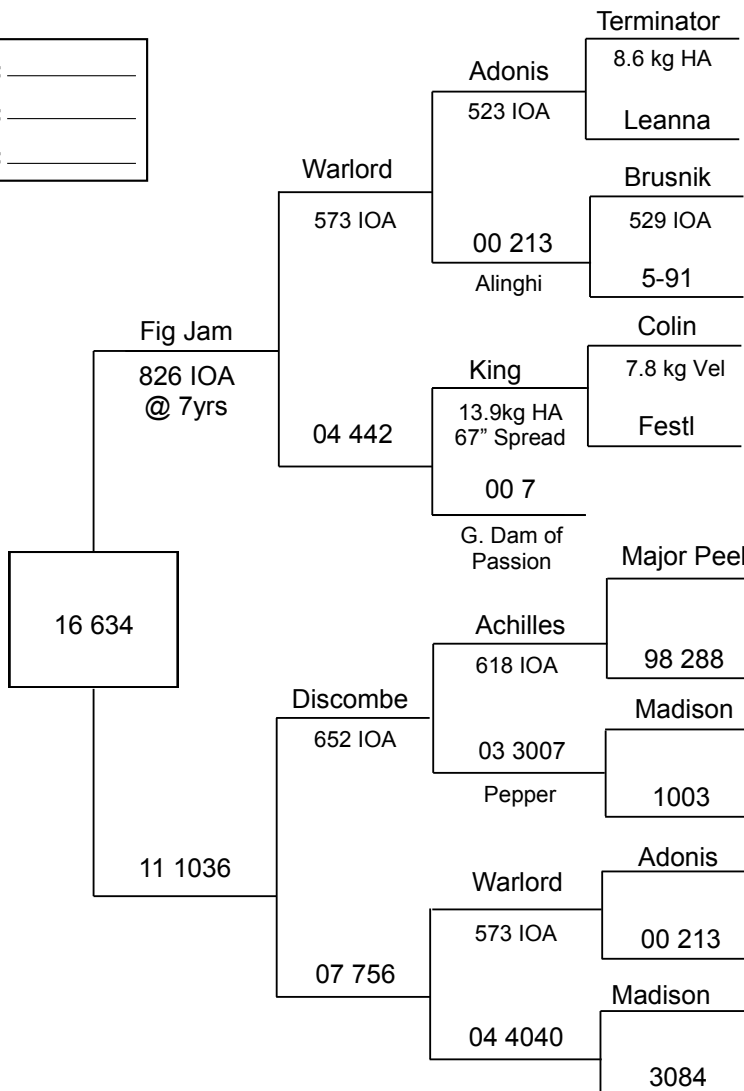

Stag 16 634 is the first and only son from dam 11 1036 who is now owned by Nick Cranston. This stag is very very impressive so far, the head is wide, very long brow and bez tynes, double right trez, bifurcating left trez, with good distance to two big bunches of royals about to split.

**Lot 10**
**R3yr Stag 16 6076**

Sale Weight: _____
Purchaser: _____
Price: _____

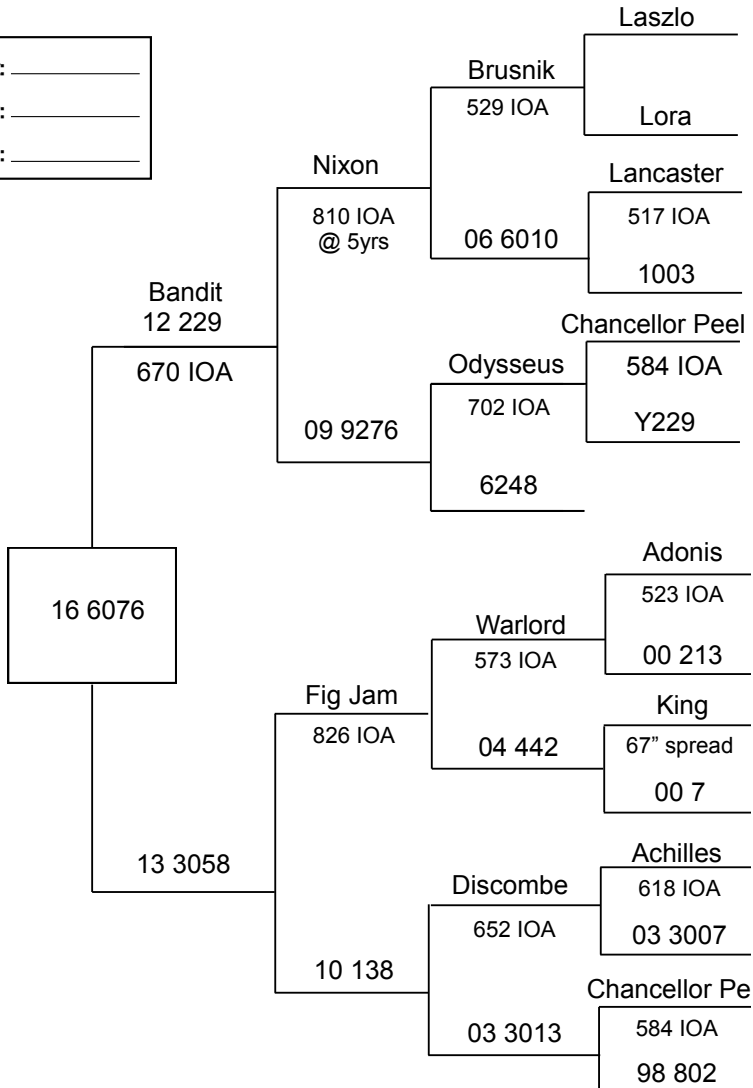

At pen time it looks like this stag trophy wise may really RIP YOUR UNDIES, the only son and offspring from dam 13 3058 now owned by James Hudson. Early head comments were.... heavy heavy brow and bez tynes, heavy fat black beam to heavy long trezs, which are bifurcating and trifurcating, large heavy dropper off left trez, long beam to humongous royal mass.



Sale Weight: \_\_\_\_\_  
 Purchaser: \_\_\_\_\_  
 Price: \_\_\_\_\_

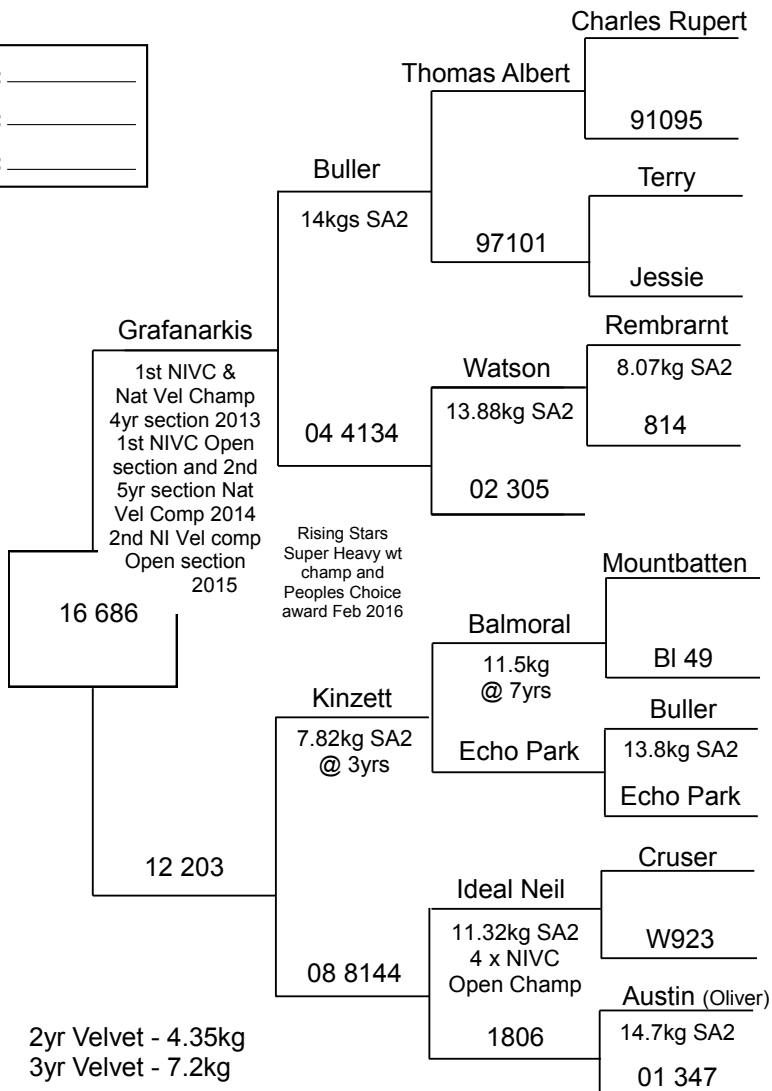

16 686 is the third son from dam 12 203, her second son featured in our 2018 stag catalogue cutting 7.15kg of velvet, we withdrew him as he split a trez tyne and spoilt our Grafanarkis SAP line up. 16 686s head this year had a very flat aspect, removal comments were, strong and long up turning brows and bezs, good length to heavy trezs, long succulent round beam to cut zone.

**Lot 12**
**R3yr Stag 16 687**

Sale Weight: _____
Purchaser: _____
Price: _____

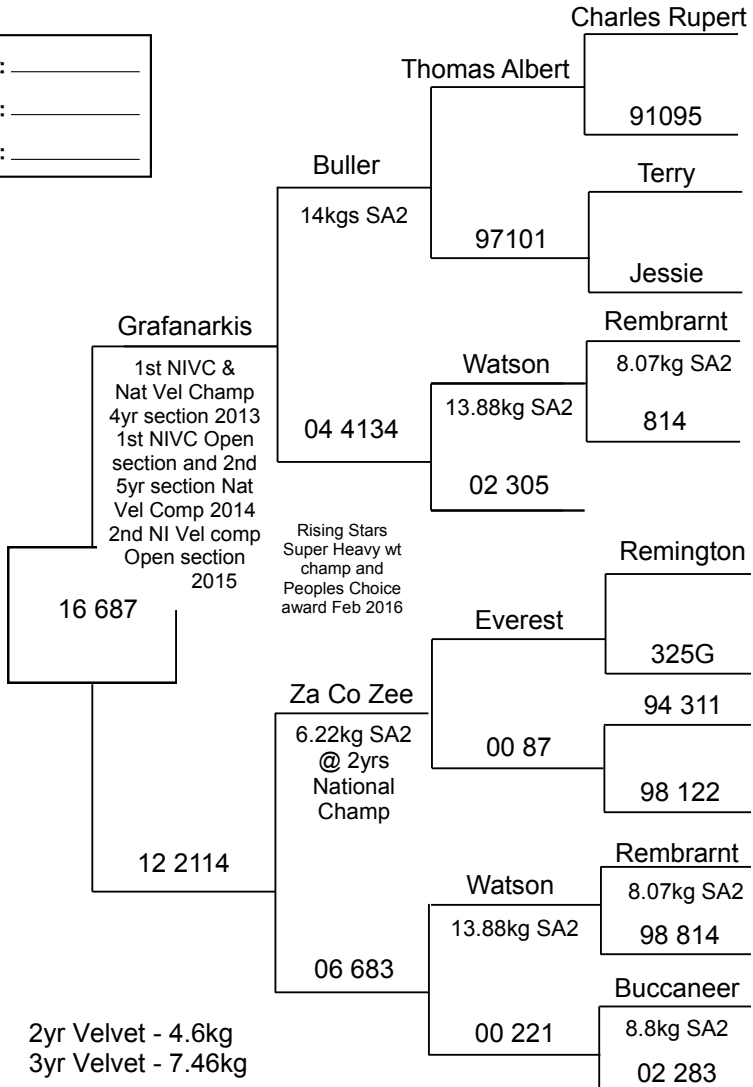

16 687 cut 4.6kgs of velvet at 2yrs, comments at velvet removal this year were Big Fat and Black, huge base 32cm coronets, very strong tynes and beam, two basals. 16 687 is the first son from dam 12 2114, who has had two other hind offspring and a weaner stag.

Sale Weight: _____
Purchaser: _____
Price: _____

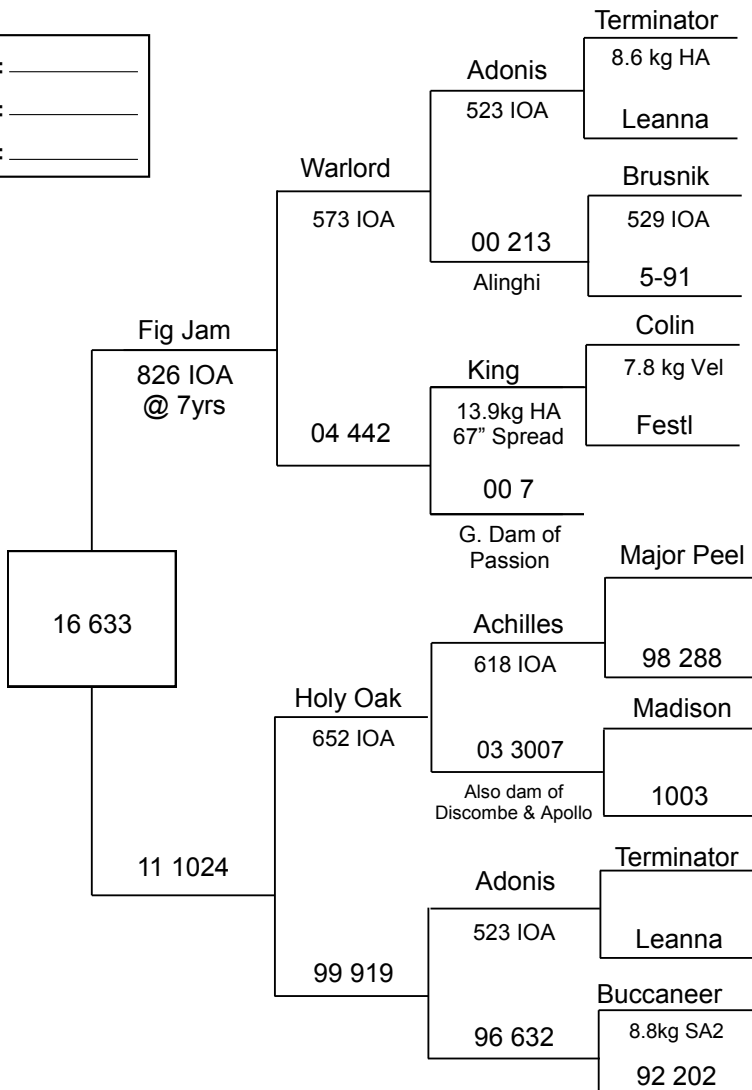

This stag is very late in antler development at 20th Nov pen time, his head is just passed the trezs, but has very heavy and strong brow, bez and trez tyne with a heavy beam. One to watch, especially as it is one of the ever reliable Fig Jam x Discombe/Holy Oak or Discombe x Fig Jam crosses which history shows to excel in great trophy stags.

## Lot 14

## R3yr Stag 16 6068

Sale Weight: _____
Purchaser: _____
Price: _____

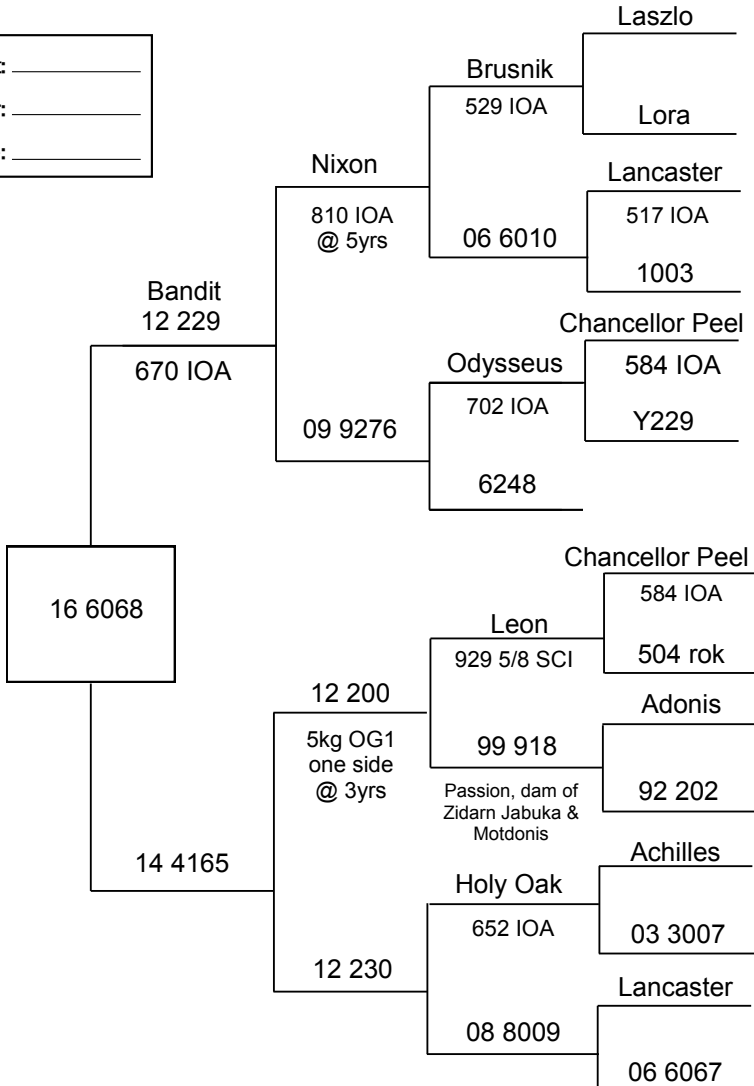

Out of first fawner 16 6068 is the only male offspring from dam 14 4165, who has left us two hinds since. His head displays straight brows, upturning bezs, good trezs with droppers off each, and like most of his brothers a big Bandit royal ready to burst.

Sale Weight: _____
Purchaser: _____
Price: _____

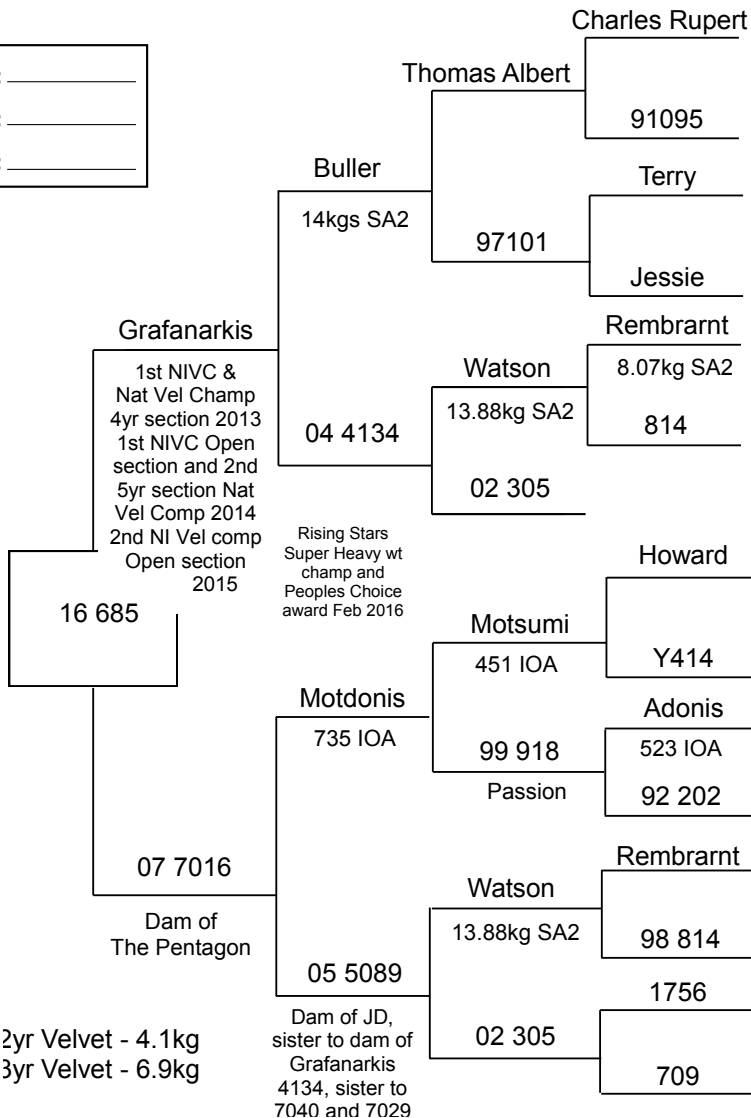

Stag 16 685 is a full brother to 'The Pentagon' one of our resident sires cutting 11kg at 5yrs. 16 685 cut 4.1kg of velvet at 2yrs and 6.9kg of perfectly symmetrical velvet this year with beam stats of 22/22, 22/21. Dam 07 7016 has produced The Pentagon, Lot 21 Dec 2015 \$7000 and another sale contender Lot 42 Aug 2019, a hind making \$9000.

**Lot 16**
**R3yr Stag 16 6089**

Sale Weight: _____
Purchaser: _____
Price: _____

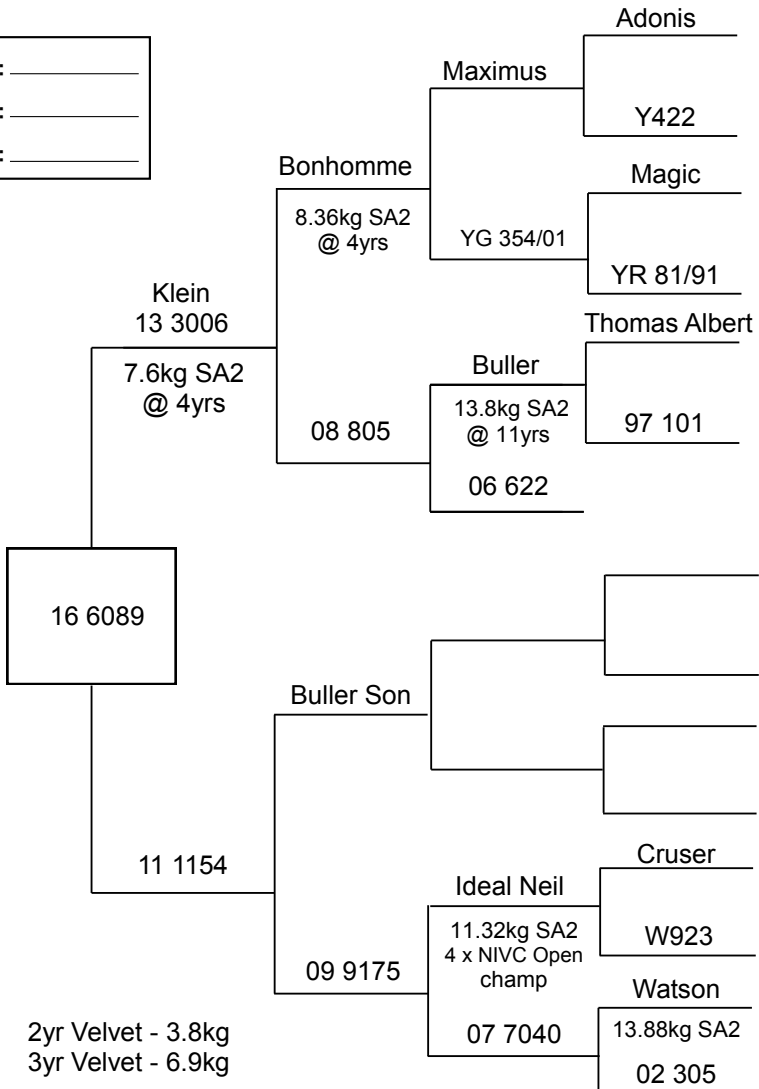

Stag 16 6089 is a half brother to Brax (Lot 6 Dec 2019, cutting 9.85kg and making \$45,000). This stag is a tall unit, he had a toe nail issue around the trez growing stage, which I over trimmed and he was sore for sometime. Grandam 09 9175 is a full sister to the dam of 3yr stag 15 5129 who cut 9.65kgs of velvet last year and sold privately for \$65,000. Great grandam 07 7040s 3yr son 15 5131 cut 8.5kgs last year, also making \$65,000.

Sale Weight: _____
Purchaser: _____
Price: _____

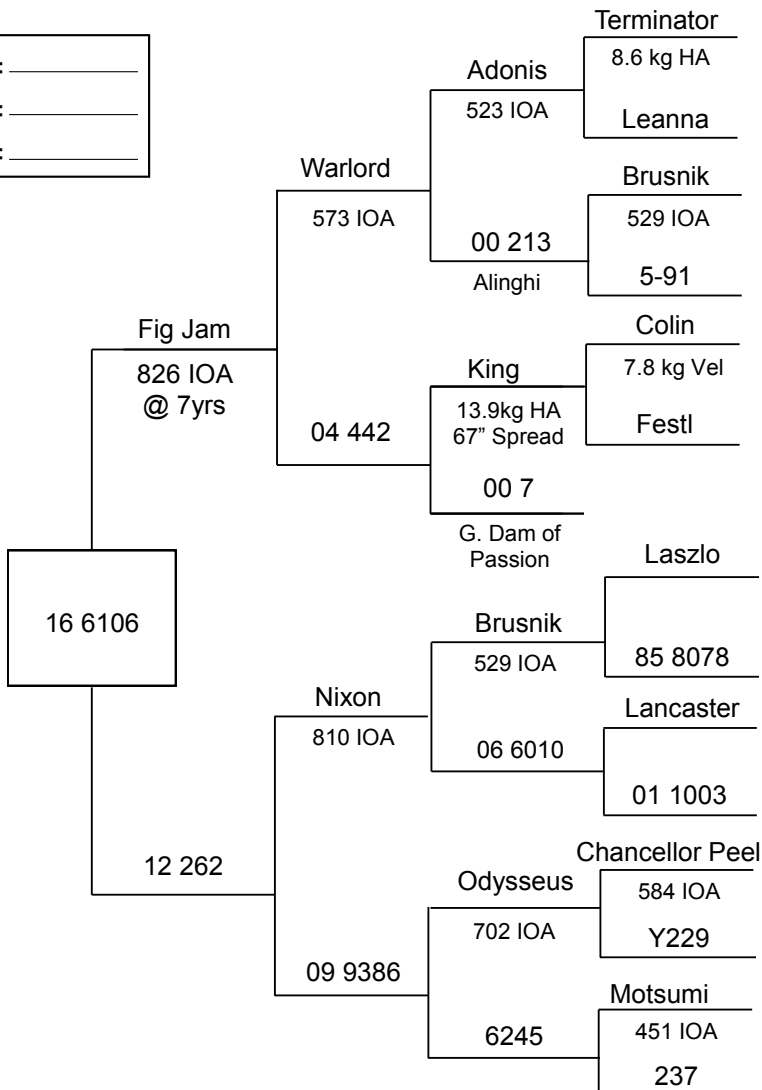

Stag 16 6106 is an embryo brother to 16 640. Like his brother his head is tracking very wide, one birds beak brow, all other three lower tyne strong and long, good length between bez and trez, left trez has three points off it, then onto a front back royal split.

## Lot 18

## R3yr Stag 16 6093

Sale Weight: _____
Purchaser: _____
Price: _____

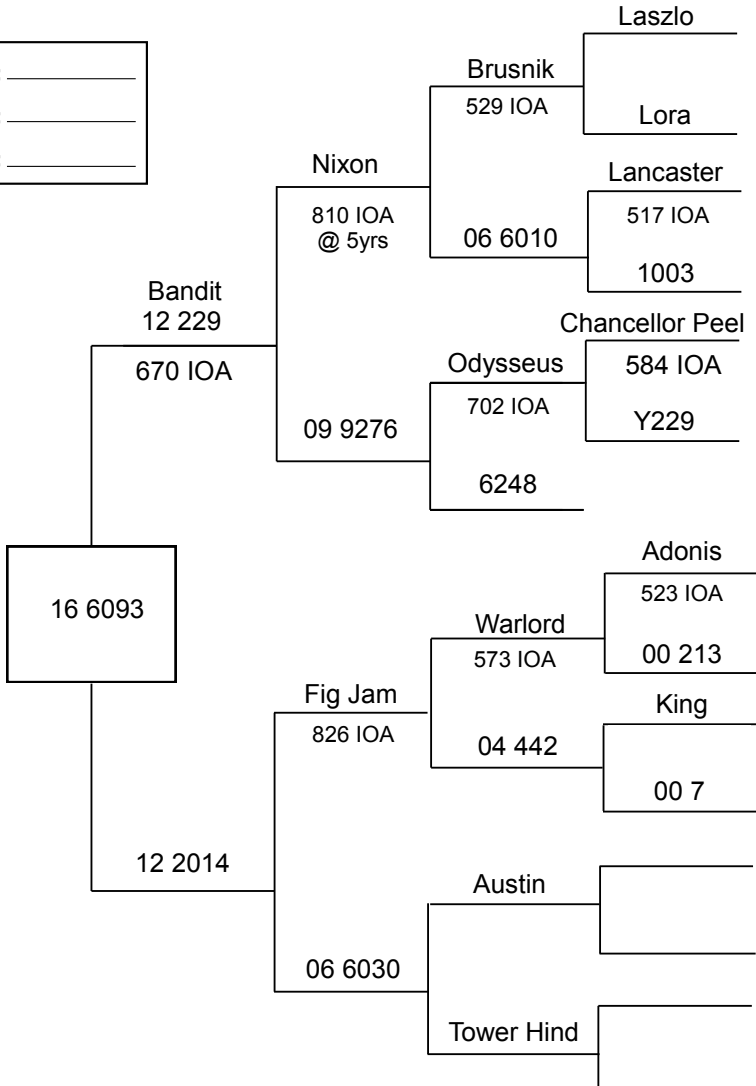

Stag 16 6093 is the only male offspring from 12 2014. His early head comments are, heavy long straight brows, heavy long upright bezs, very good length trez with good distance between the tynes, with huge Bandit royals on the way.



Sale Weight: \_\_\_\_\_  
 Purchaser: \_\_\_\_\_  
 Price: \_\_\_\_\_

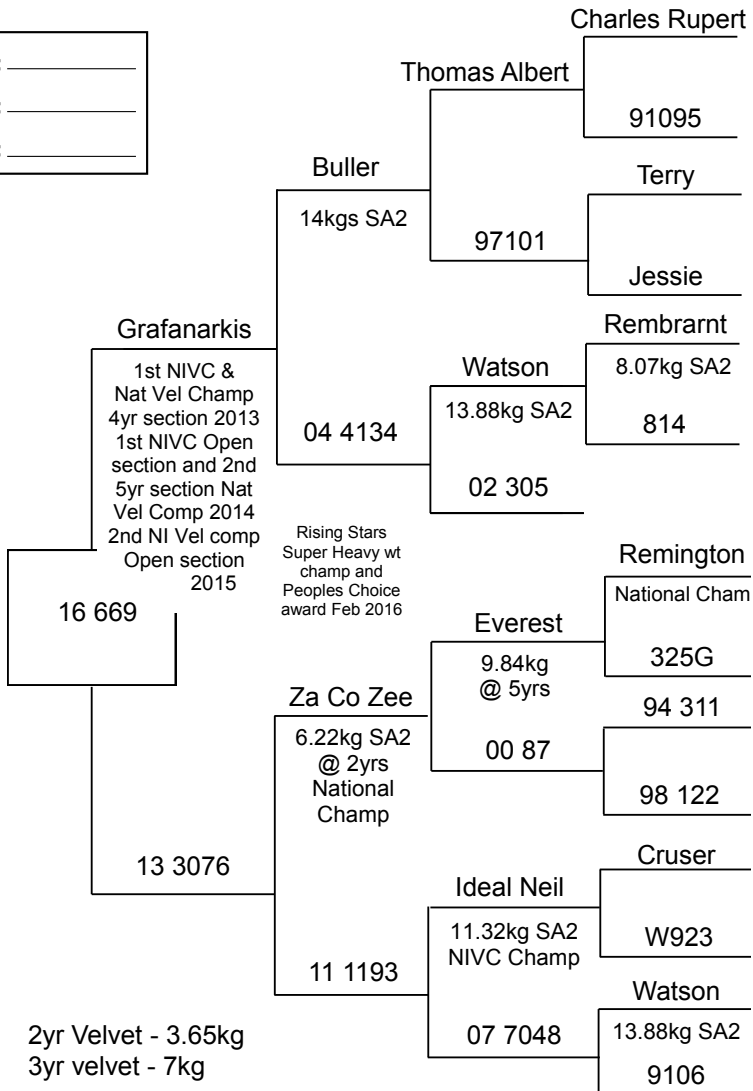

Stag 16 669 cut beautiful 'fat n black' velvet with beam stats of 22/22 and 24/21, removal comments were huge base, very strong brows, left bez lighter, fat black beam, one side early, one side late, or high trez, low trez.

Lot 20

R3yr Stag 16 6114

Sale Weight: \_\_\_\_\_  
 Purchaser: \_\_\_\_\_  
 Price: \_\_\_\_\_

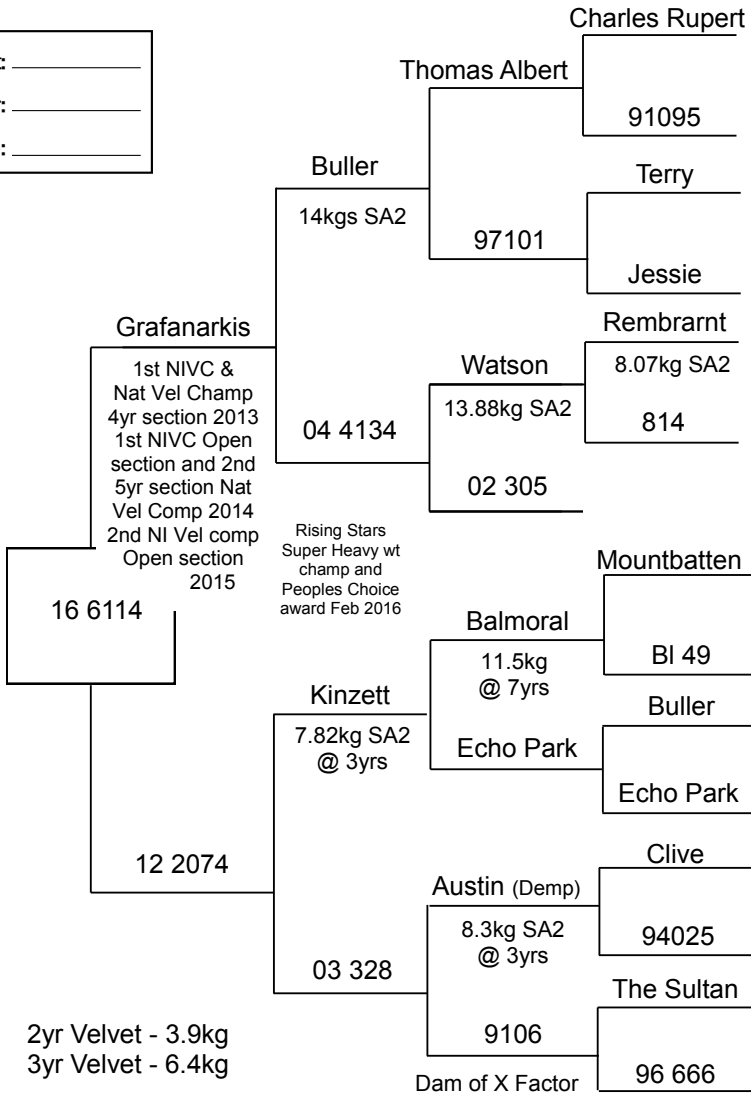

Beautiful wide and perfectly symmetrical in most everyway and a bomb proof temperament is the package you get with 16 6114. Good tynes, excellent placement, everything is round and clean.

Sale Weight: _____
Purchaser: _____
Price: _____

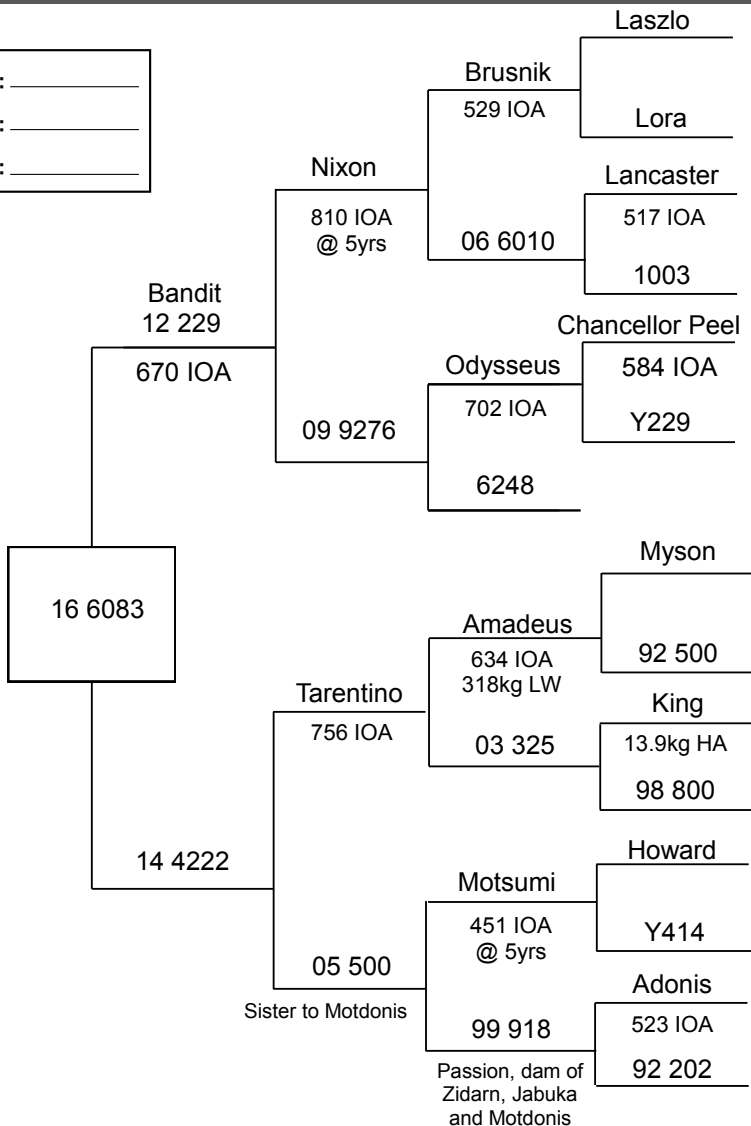

3yr stag 16 6083 is the only offspring we have from dam 14 4222 who is now owned by Mt Cecil. His head showed on 20th Nov that it was a heavy head going wide, the lower tynes were good medium brow and bez, heavy beam just at the trezs, looks like droppers to come off each.



Sale Weight: _____
Purchaser: _____
Price: _____

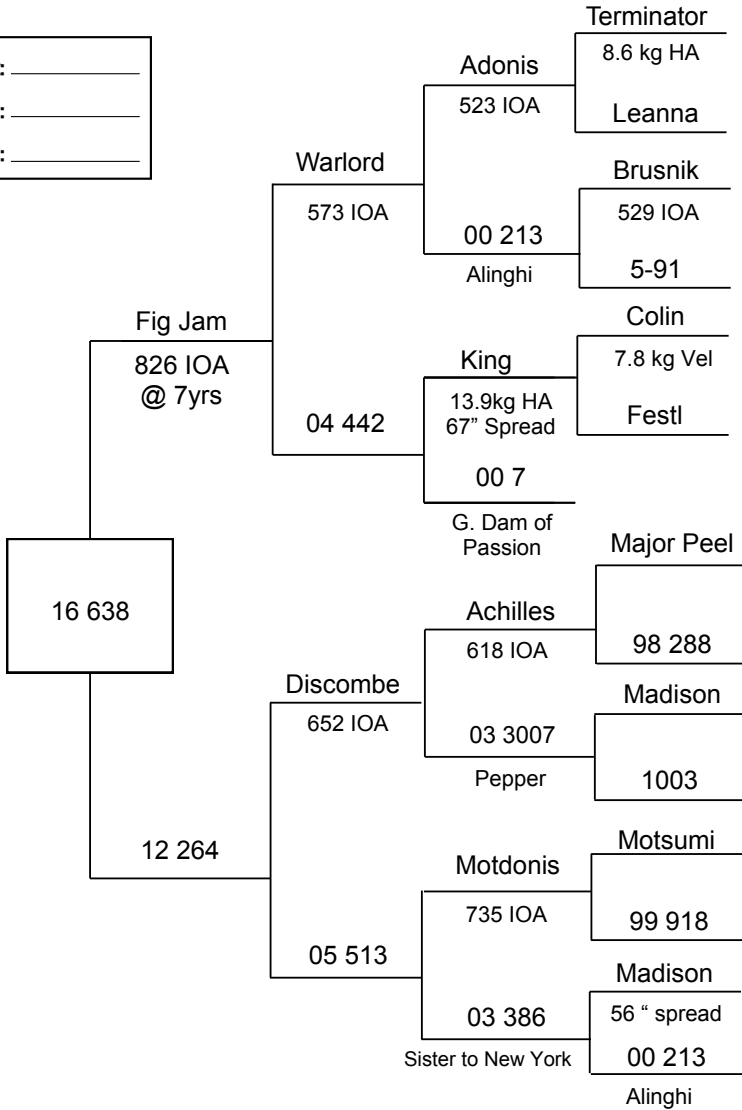

Stag 16 638 is the only male offspring from dam 12 264, she also has a R1yr stag on farm by Trump. At pen time 20th Nov, 16 638s head had a very flat aspect, strong up turning brows and bezs, bifurcating left trez with two rows of Fig Jam royals about to start.

Sale Weight: _____
Purchaser: _____
Price: _____

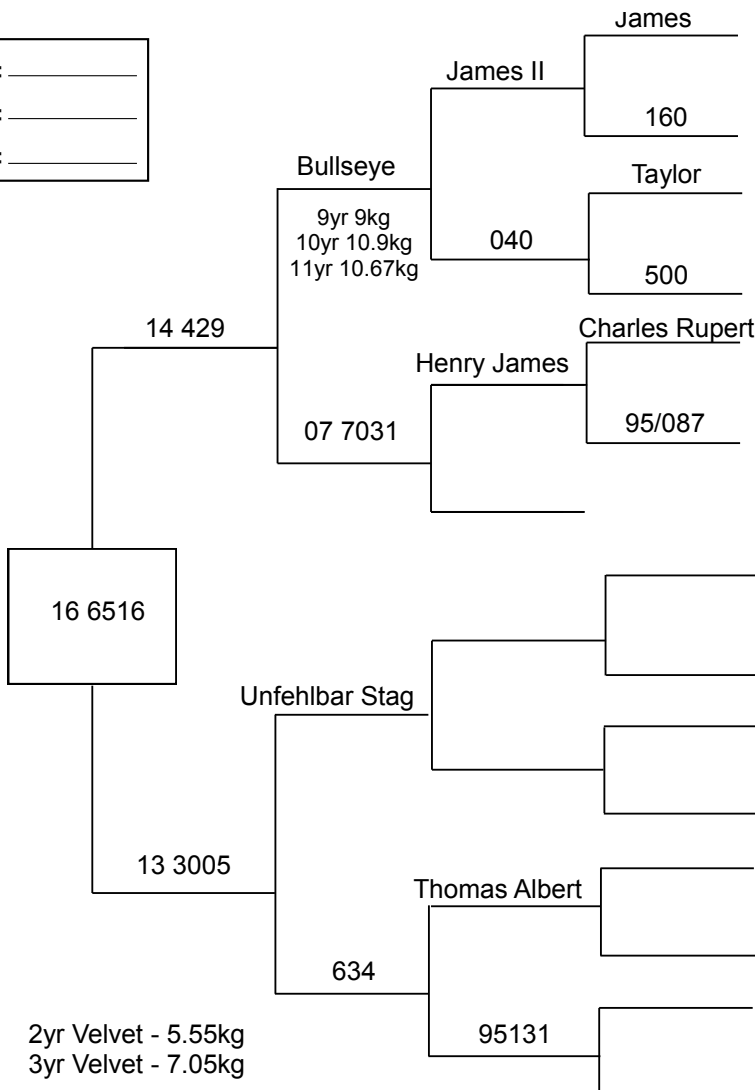

This stag cut a very long scopey Thomas Albert style head, the aspect was extremely wide. The Warnham pedigree reflects the contribution of 040 topline (sister to the dam of Walton) and 634 bottom line (full sister to Murchison), the head displayed one strait D.P.B, very strong bez and trez, with long length between the bez and trez, and long to flattish royal. One side LT.

Sale Weight: \_\_\_\_\_  
 Purchaser: \_\_\_\_\_  
 Price: \_\_\_\_\_

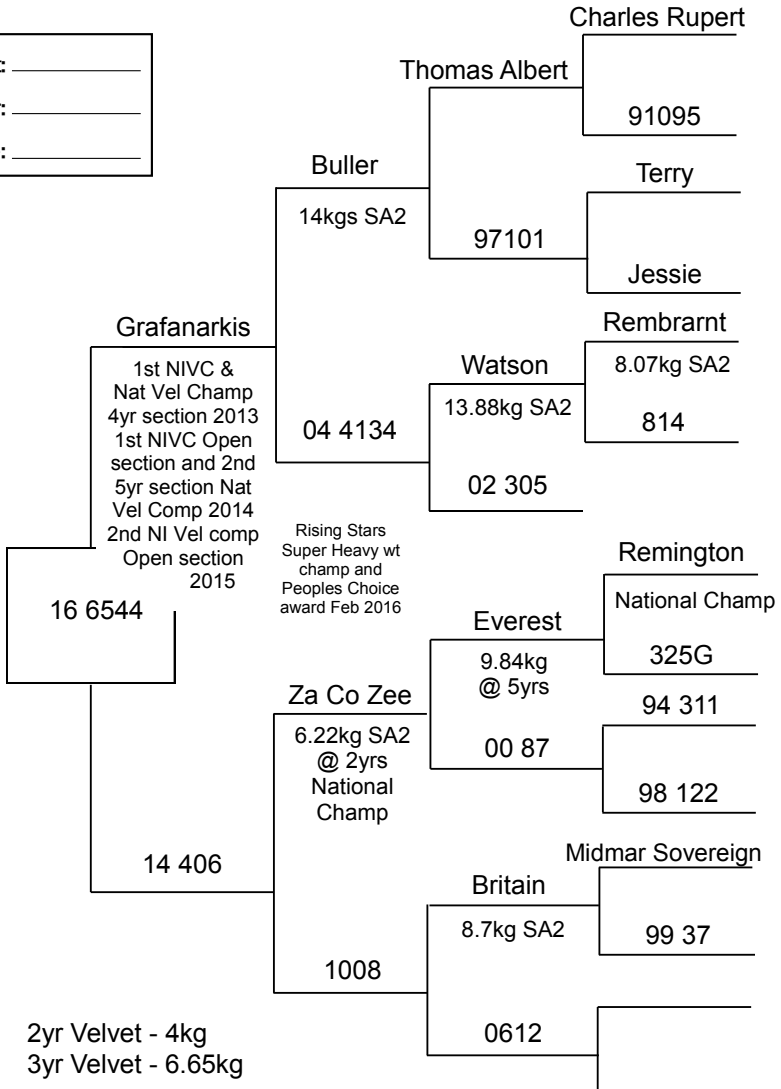

A slightly different Grafanarkis style head from 16 6544. He has way long and strong brow, bez and trez, beam is round and black 24/19 21/19, good length to high trez, cut 15 and 10cms above trez, one side early, one side late. Excellent temperament.

Sale Weight: _____
Purchaser: _____
Price: _____

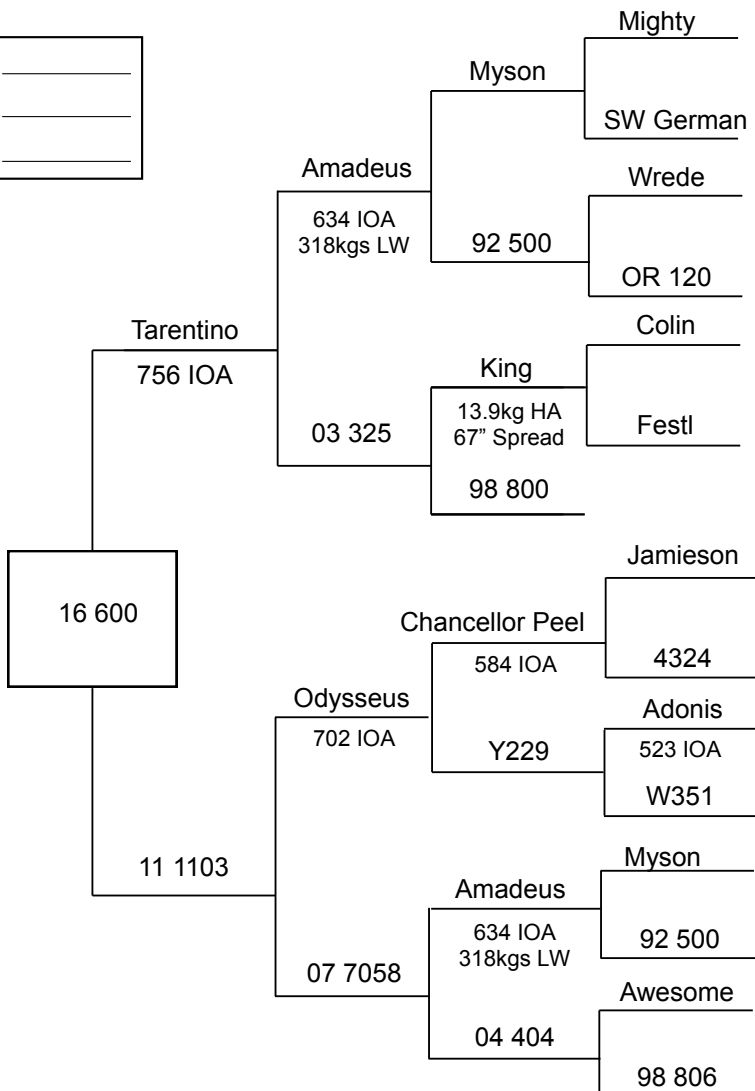

16 600 is the second son from 11 1103, her first selling Dec 2018, Lot 10 for \$15,000 to Nick Cranston.

Sale Weight: _____
Purchaser: _____
Price: _____

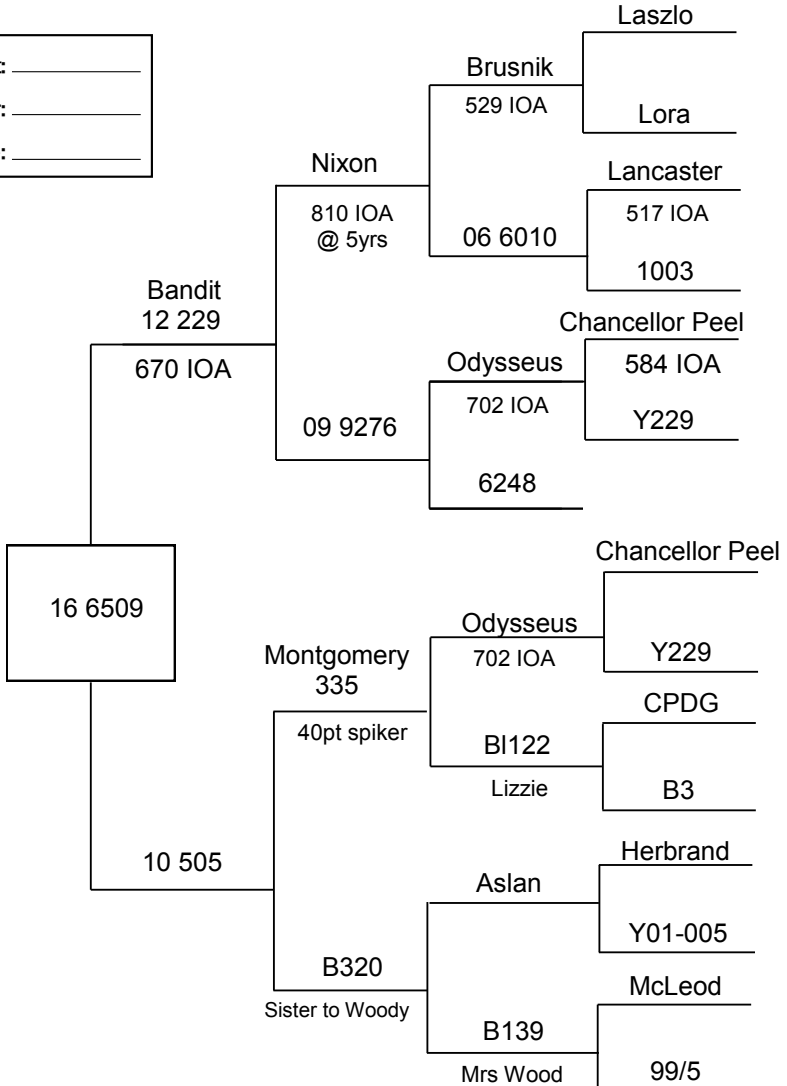

16 6509s head displayed two straight chunky heavy brows, with four points off right hand side and three off left hand side, heavy base, fat thick bezs, short to heavy trezs, the right hand side just forming with a dropper, and a rear trez dropper left hand side, flat after that. Is this the start of another 'Woody' previous world number one, SCI record holder.



Sale Weight: _____
Purchaser: _____
Price: _____

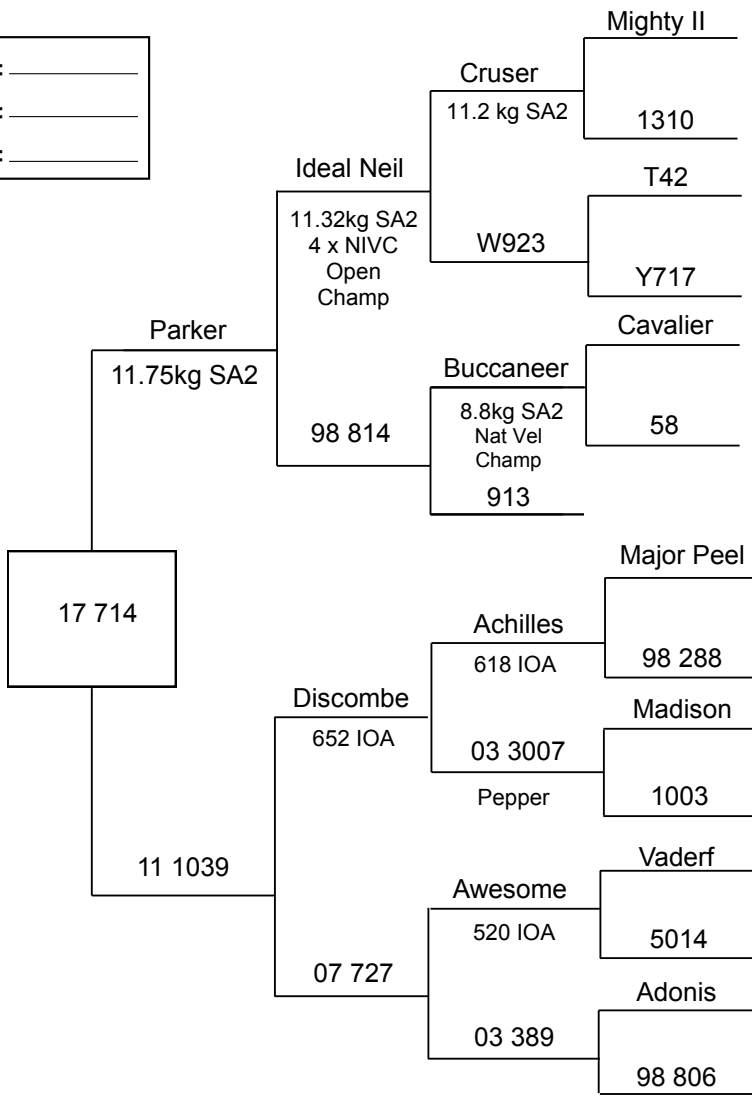

Duel purpose hind for both velvet and trophy. Dam 11 1039 is a half sister to the dam of sire Beauden.

Lot 28

R2yr Hind 17 7025

Sale Weight: _____
Purchaser: _____
Price: _____

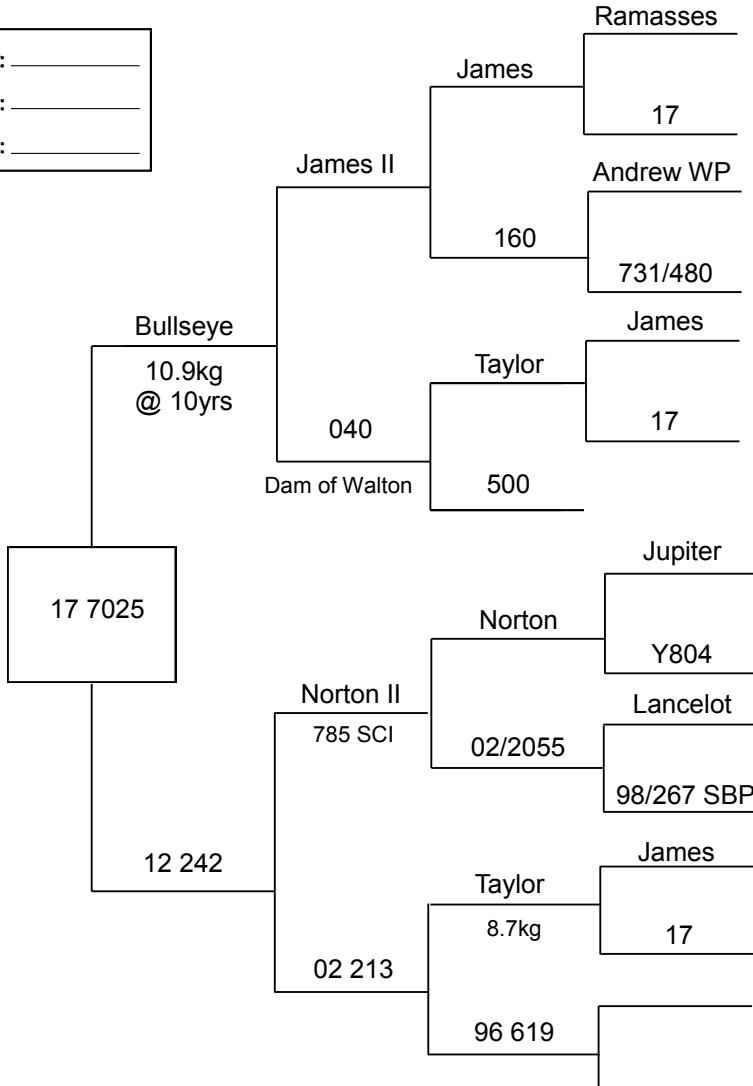

Pure Warnham daughter by Bullseye 10.9kg @ 10yrs, a half brother to Walton 12.5kg SAV @ 6yrs.

Sale Weight: _____
Purchaser: _____
Price: _____

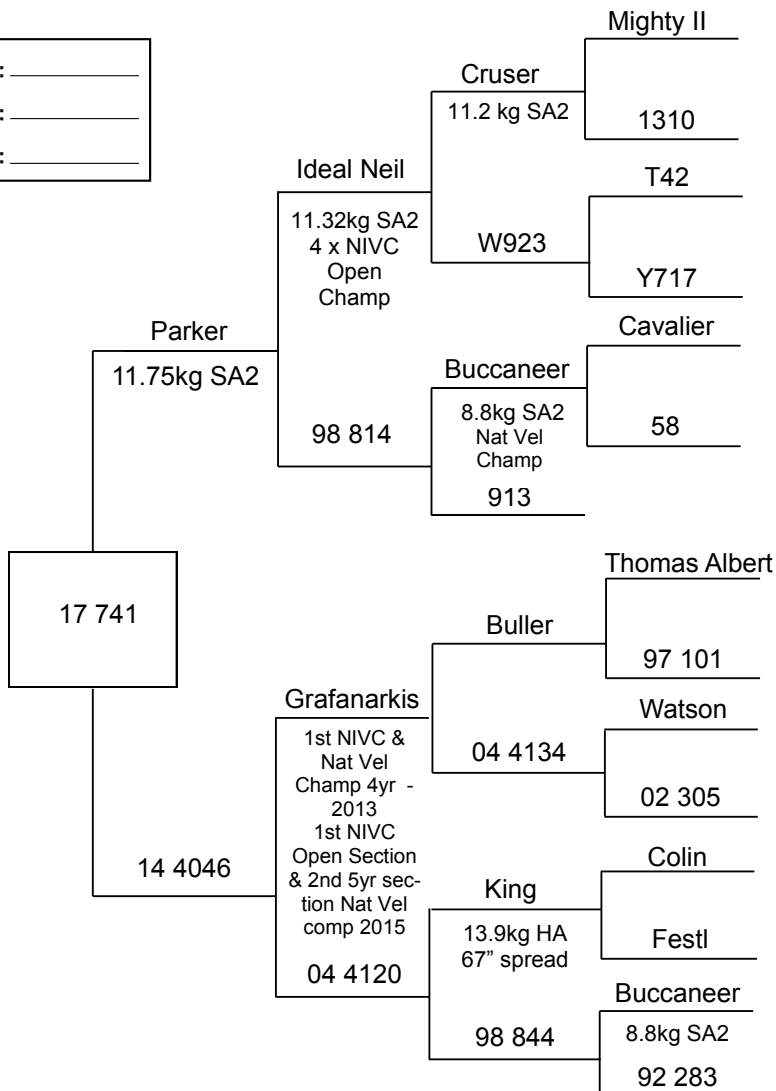

Excellent velvet pedigree with the thickness of Parkers head over the stretch of Grafanarkis's. Dam 14 4046 has had only female offspring to date, grandam 04 4120 was the dam of a top Watson son sold to Bob Sharp.

**Lot 30**
**R2yr Hind 17 757**

Sale Weight: _____
Purchaser: _____
Price: _____

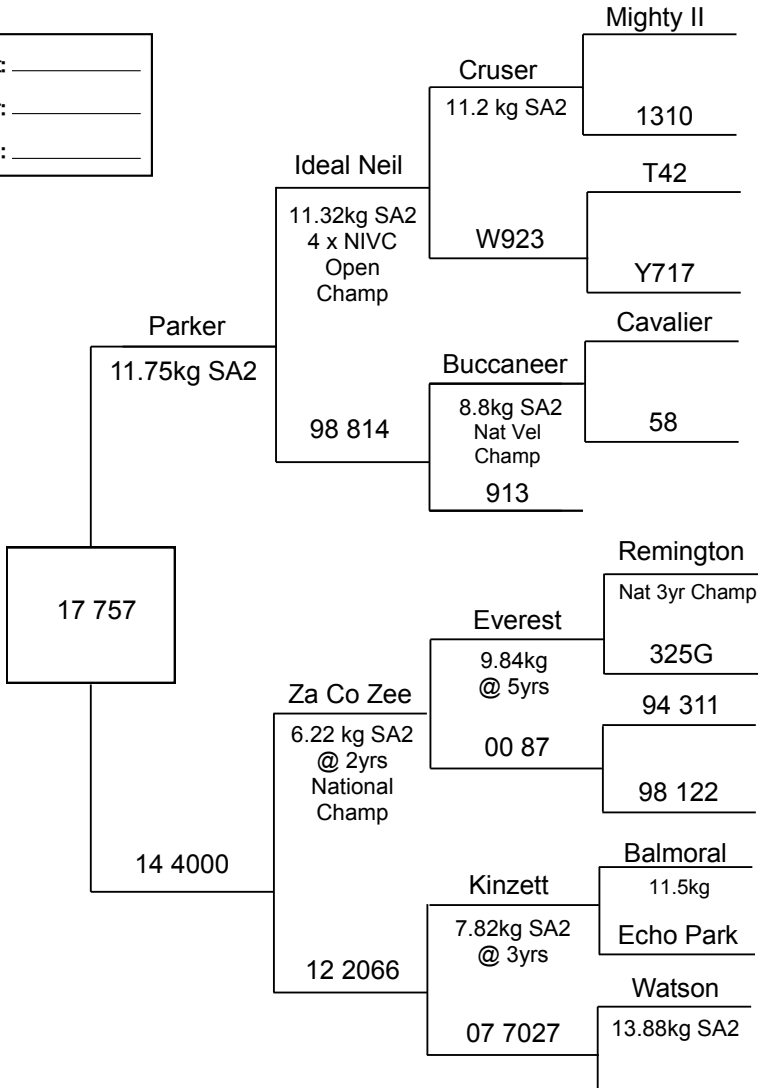

Great mix of velvet genetics from Altrive, Echo Park and Tower Farms in this pedigree with velvet champions scattered all through out.

Sale Weight: _____
Purchaser: _____
Price: _____

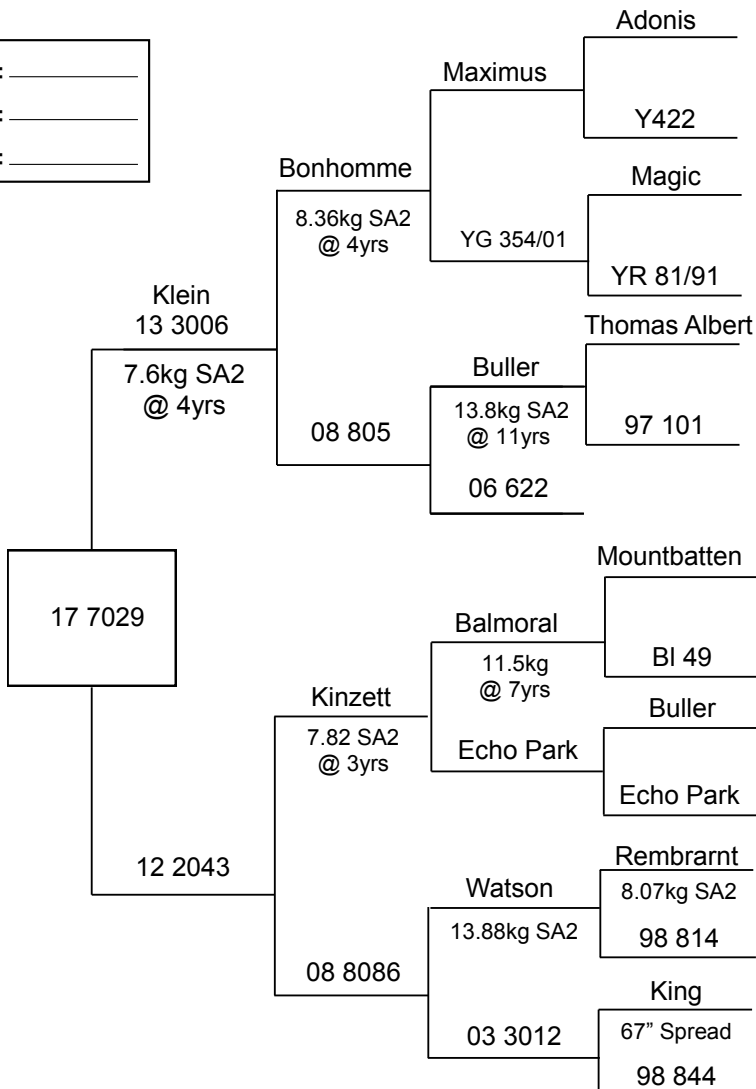

Four daughters and one 1yr stag from dam 12 2043 so far. Grandam 08 8086 sold July 15 hind sale to John Ramsey. Great grandam 03 3012 produced six daughters with her top 2yr son 4.5kg. Klein was a stand out 2yr old for both velvet and temperament but unfortunately suffered a bad hoof infection at 3yrs which has always hampered his own performance.

**Lot 32**
**R2yr Hind 17 766**

Sale Weight: _____
Purchaser: _____
Price: _____

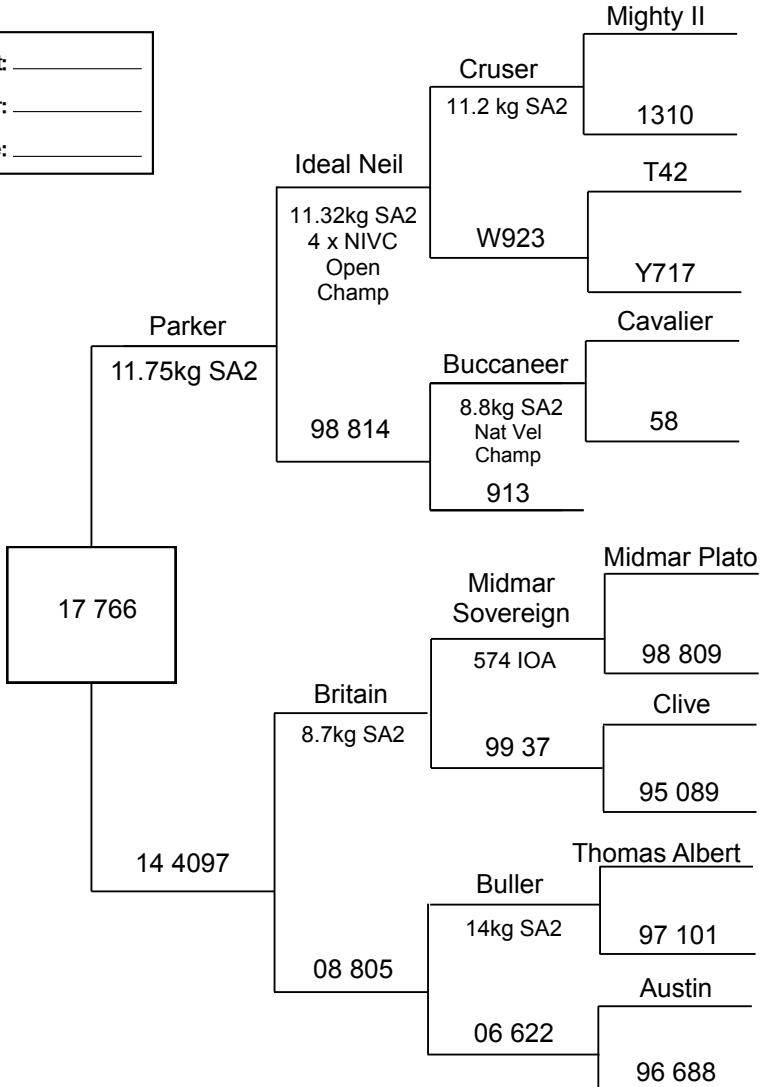

Parker across a half sister to sires Klein and Brexit (Lot 7, 2017 \$27,000 to Forest Road Farm), similar bottom line to Lot 8 last year \$41,000.

Sale Weight: _____
Purchaser: _____
Price: _____

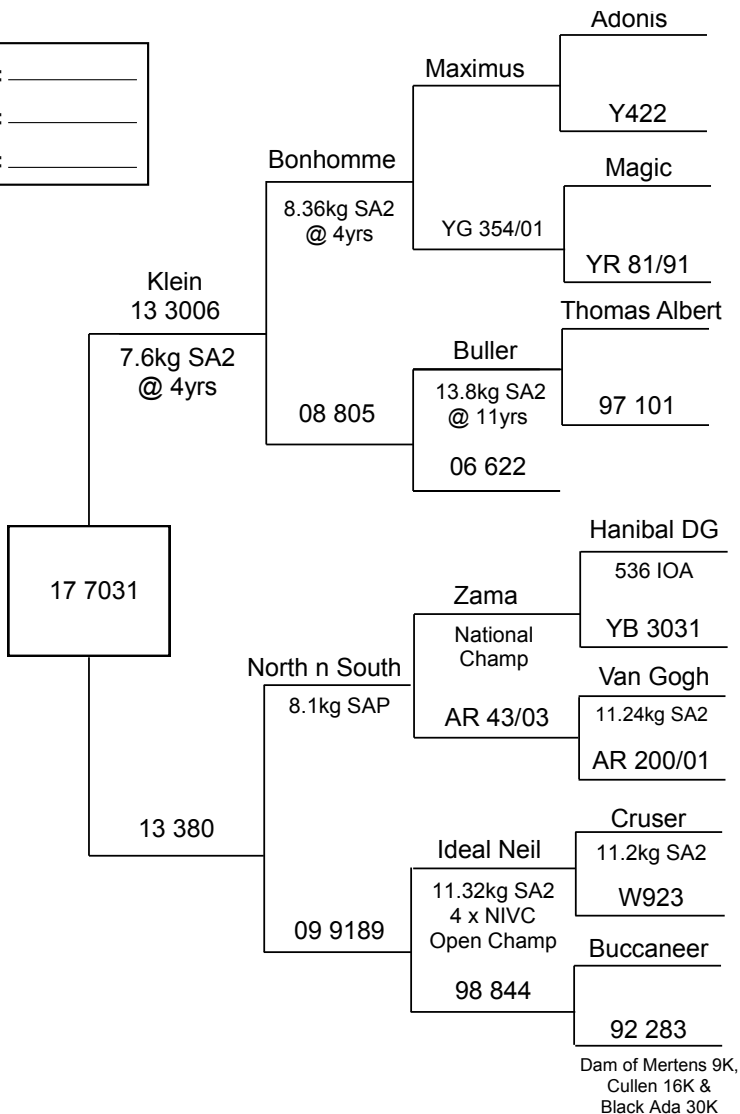

Quality bottom line and ultra consistent. Dam 13 380's half sister produced Lot 6 Dec 18 \$57,000 - 14 4172 (Bluerock) 9kgs at 3yrs - 4th national 3yr 2018. 13 380 was sold in our August hind sale for \$5000 to Forest Road Farm.



Lot 34

R2yr Hind 17 797

Sale Weight: \_\_\_\_\_  
 Purchaser: \_\_\_\_\_  
 Price: \_\_\_\_\_

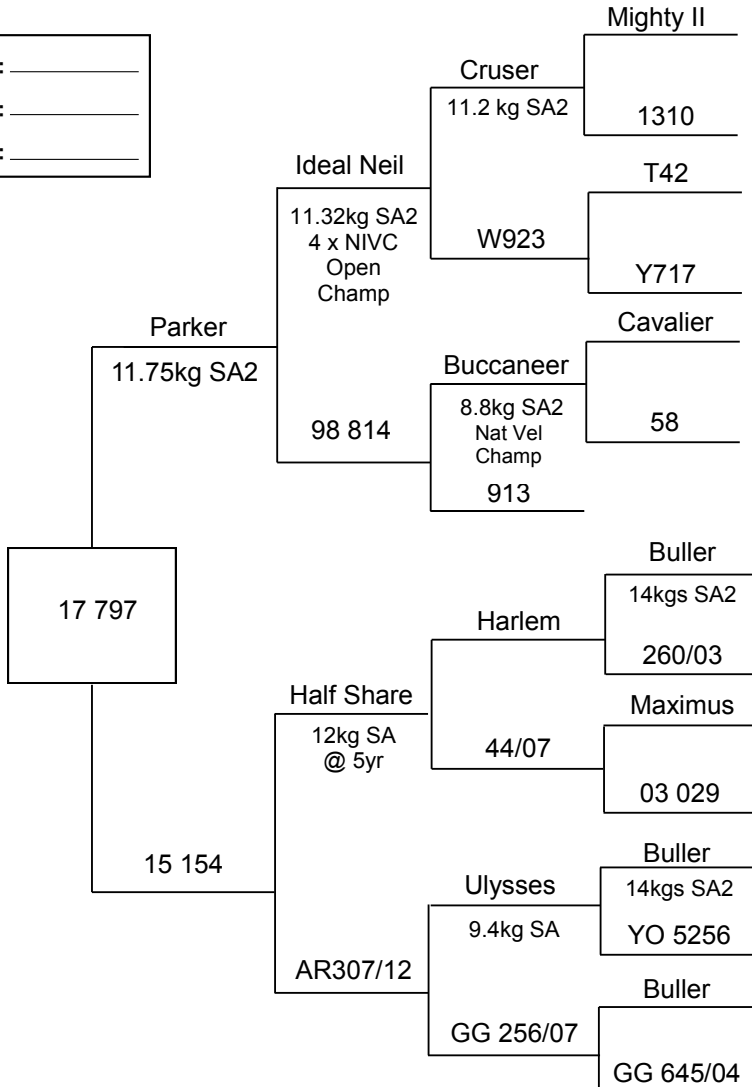

Great cross of velvet styles here with the thickness and bulb of Parker and Ideal Neil over the length of this Arawata bottom line dominated by Buller.



Sale Weight: \_\_\_\_\_  
 Purchaser: \_\_\_\_\_  
 Price: \_\_\_\_\_

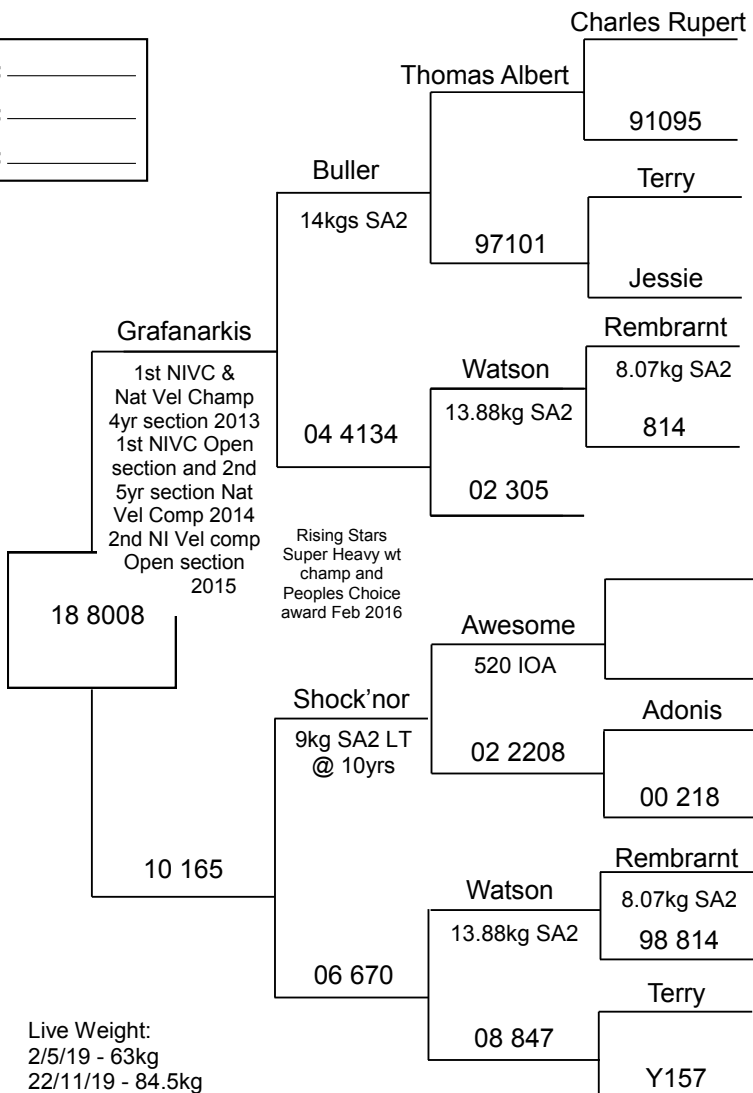

Powerful line up of heavy weight velvet genetics with Grafanarkis, Buller, Shock'nor and Watson.

Sale Weight: _____
Purchaser: _____
Price: _____

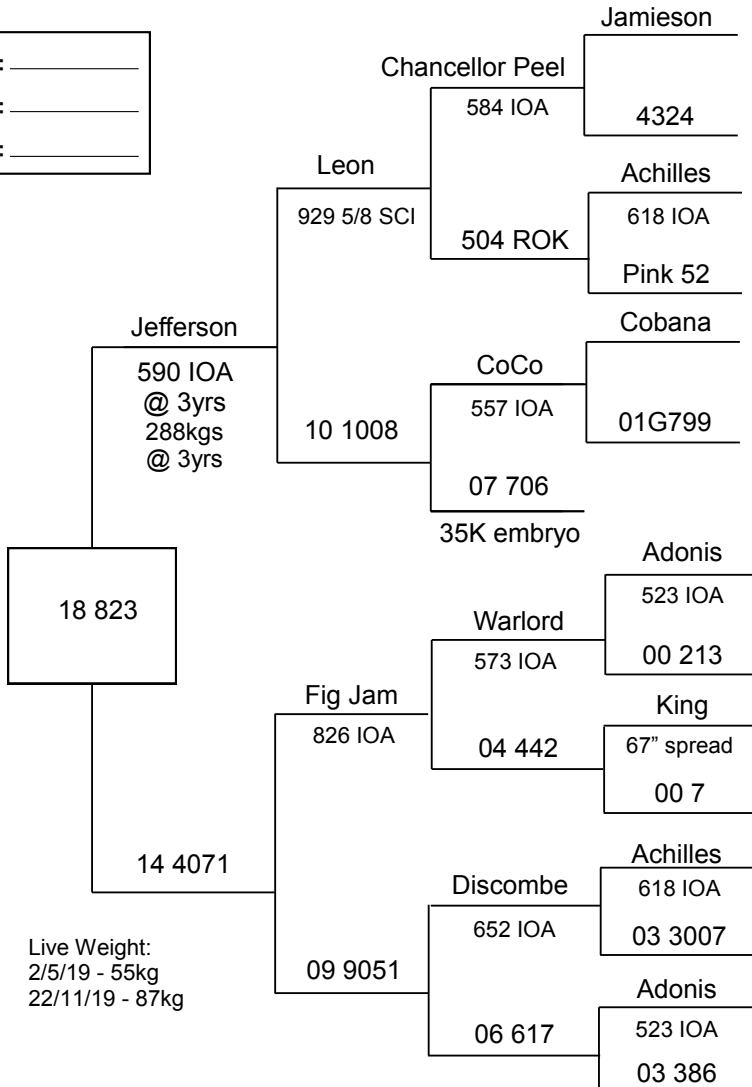

Live Weight:  
2/5/19 - 55kg  
22/11/19 - 87kg

Jefferson's massive number of points over the spread of both Fig Jam and Discombe and the consistency of that cross should enhance 18 823's ability to produce the goods. Dam 14 4071's full brother was sold Dec 16 for \$10,000 to Andrew Scurr, and 06 617s top son sold Dec 16 also for \$12,000 to Pinewood Deer.

Sale Weight: _____
Purchaser: _____
Price: _____

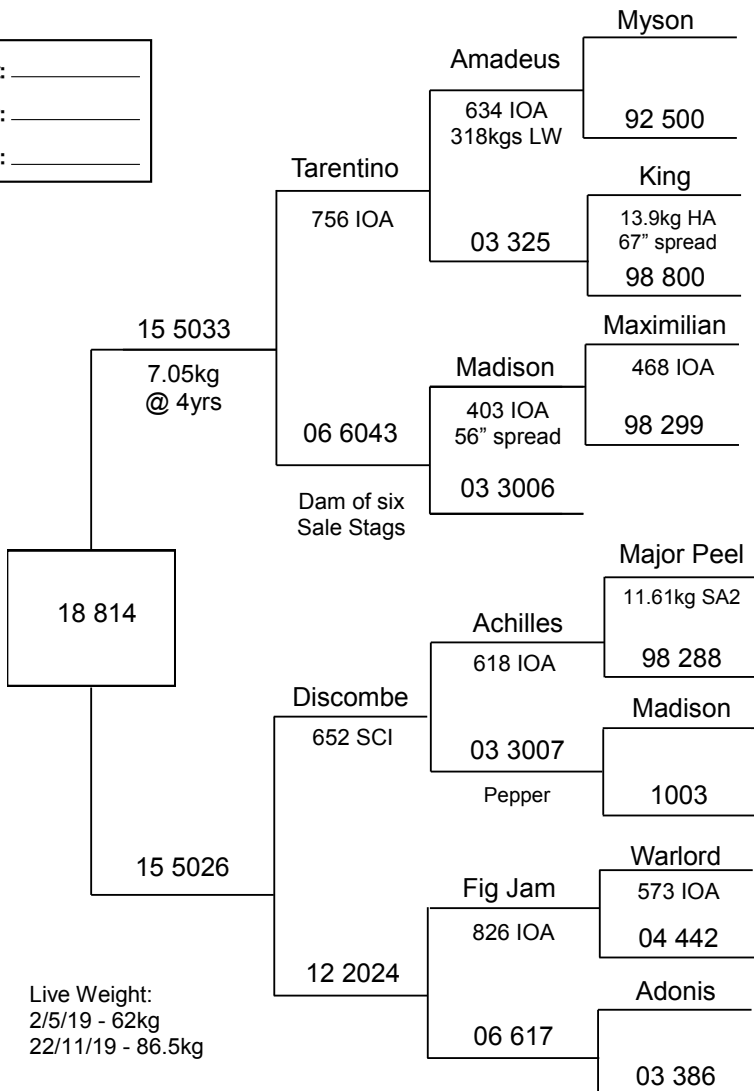

Live Weight:  
 2/5/19 - 62kg  
 22/11/19 - 86.5kg

A tonne of spread in this trophy pedigree from Tarentino, Madison, Discombe and Fig Jam. Dam 15 5026 produced two daughters before being sold in our August Hind Sale for \$6500. Grandam 12 2024 has a daughter on farm by Bandit and a one year son by Jefferson.

**Lot 38**
**R1yr Hind 18 833**

Sale Weight: _____
Purchaser: _____
Price: _____

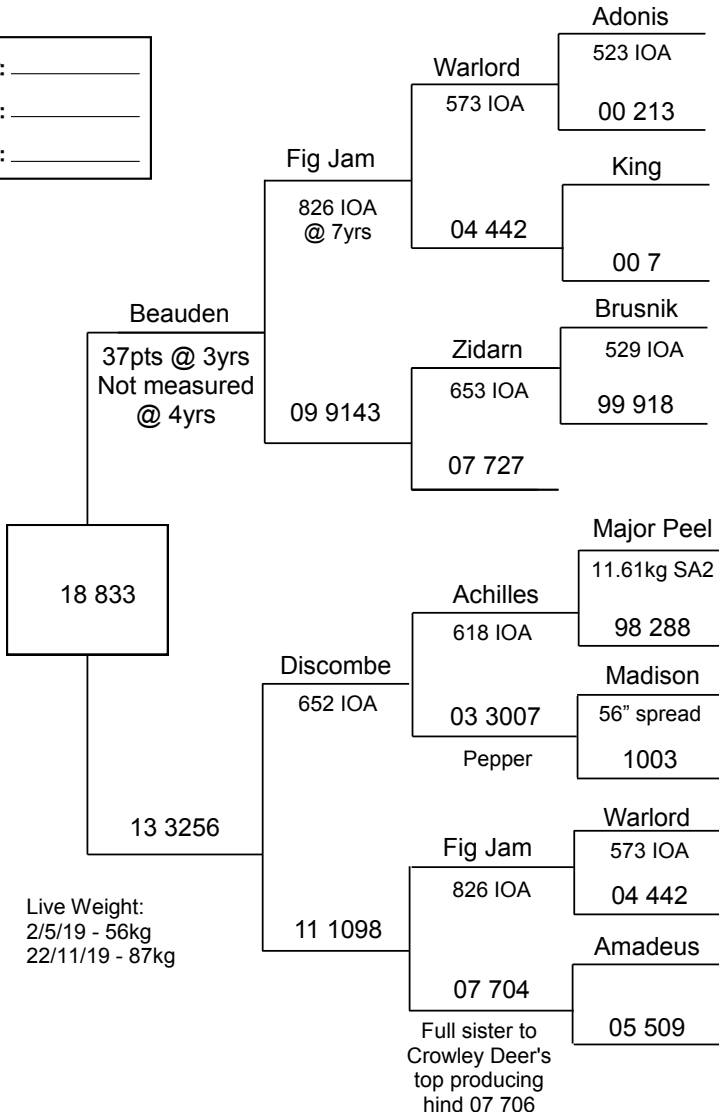

A double shot of Fig Jam in this pedigree should ensure 18 833s offspring have an abundance of width and points. Dam 13 3256s only daughter to date.

Sale Weight: \_\_\_\_\_  
 Purchaser: \_\_\_\_\_  
 Price: \_\_\_\_\_

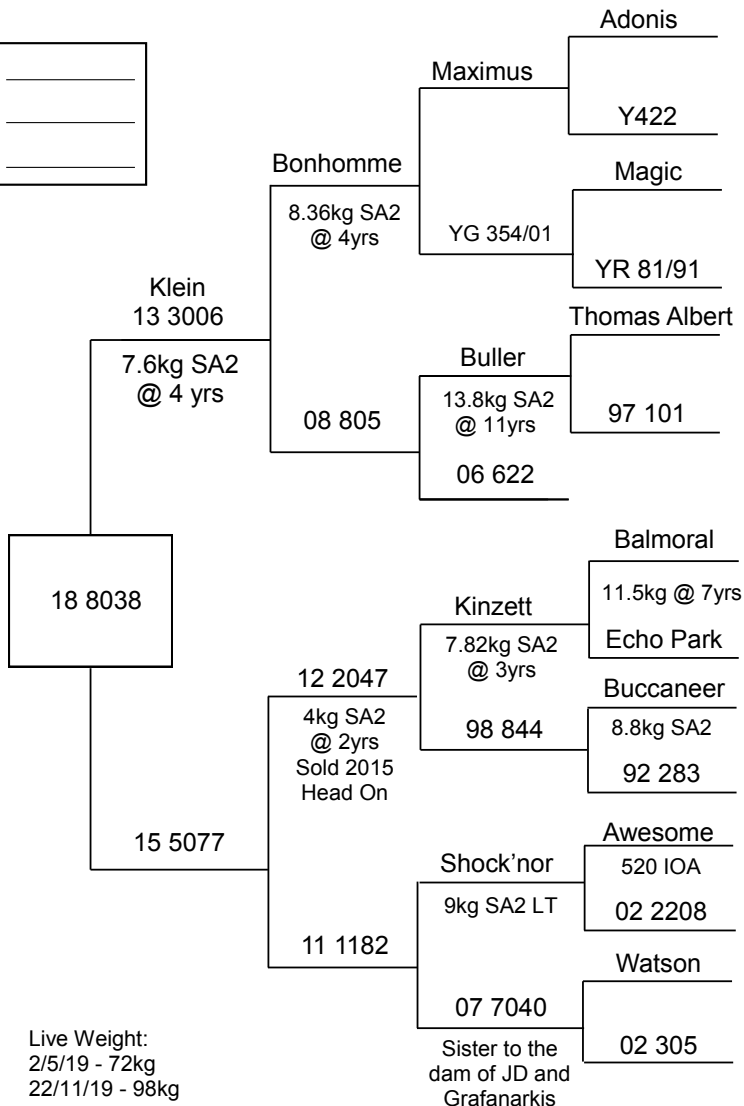

Live Weight:  
 2/5/19 - 72kg  
 22/11/19 - 98kg

Two daughters from dam 15 5077 to date. Grandam 11 1182 is a half sister to top priced sale stag last year \$65,000 sold to John Ramsey and also Lot 9 Dec 15 \$17,000 sold to Greg Webb.

**Lot 40**
**R1yr Hind 18 8058**

Sale Weight: _____
Purchaser: _____
Price: _____

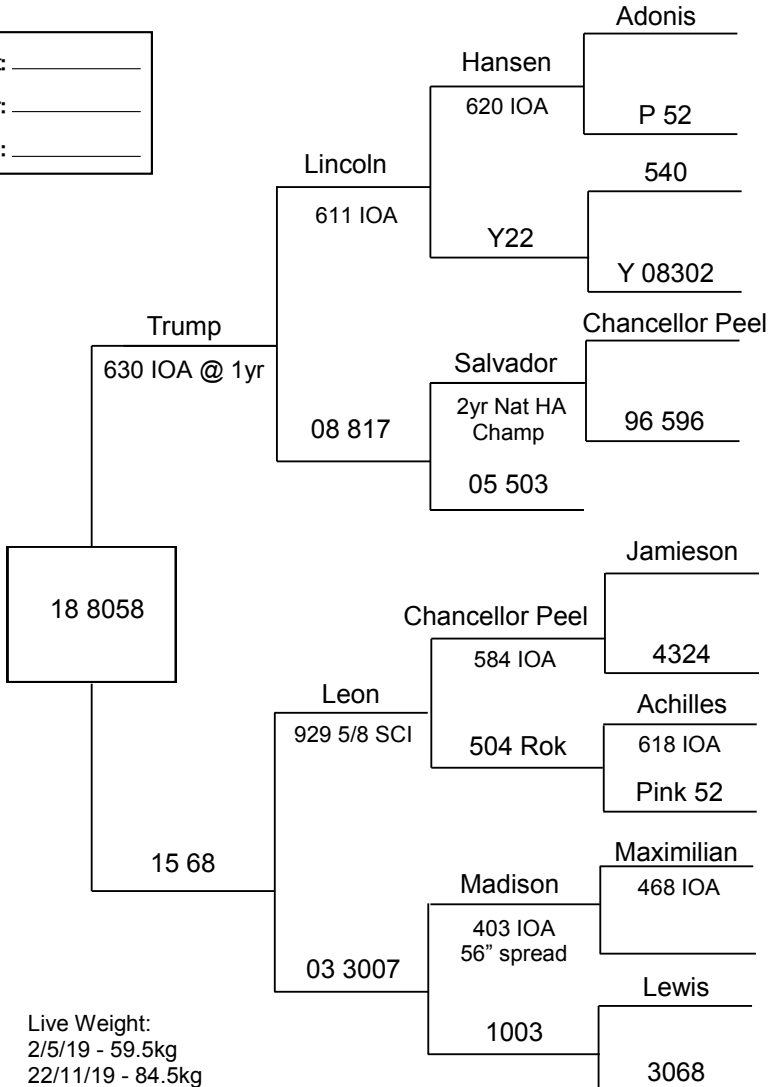

Live Weight:  
 2/5/19 - 59.5kg  
 22/11/19 - 84.5kg

Trump a world record spiker and full brother to Rockafella over Leon, currently the highest scoring stag ever, anchored by Pepper, dam of Discombe, Holy Oak and Apollo. Incredible trophy genetics.

Sale Weight: _____
Purchaser: _____
Price: _____

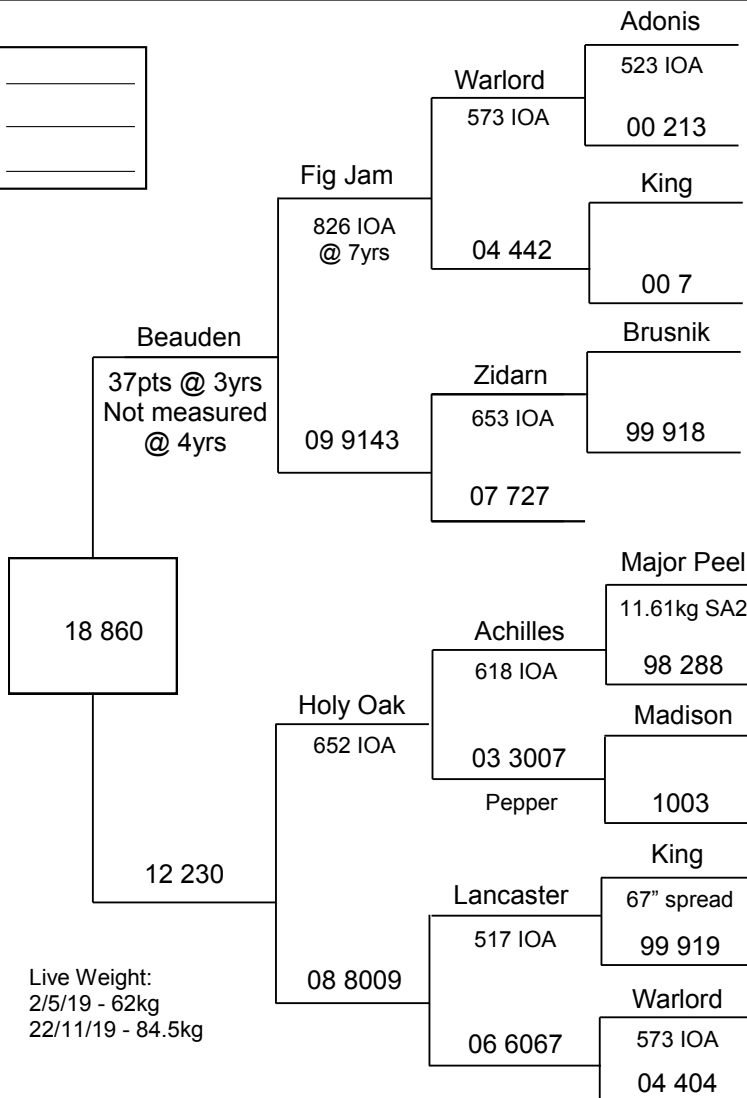

Live Weight:  
2/5/19 - 62kg  
22/11/19 - 84.5kg

Exciting bottom line in 18 860s pedigree, while 12 230 has produced all daughters, granddam 08 8009 is a half sister to the dam of Canes Cognac by Davidson who was around 600 IOA at 3yrs. Both 08 8009 and daughter were purchased by Crowley Deer. 06 6067 produced the top price sale stag in Jan 13 by Discombe and is a full sister to Foveran's Windsor 608 IOA.



Lot 42

R1yr Hind 18 8027

Sale Weight: \_\_\_\_\_  
 Purchaser: \_\_\_\_\_  
 Price: \_\_\_\_\_

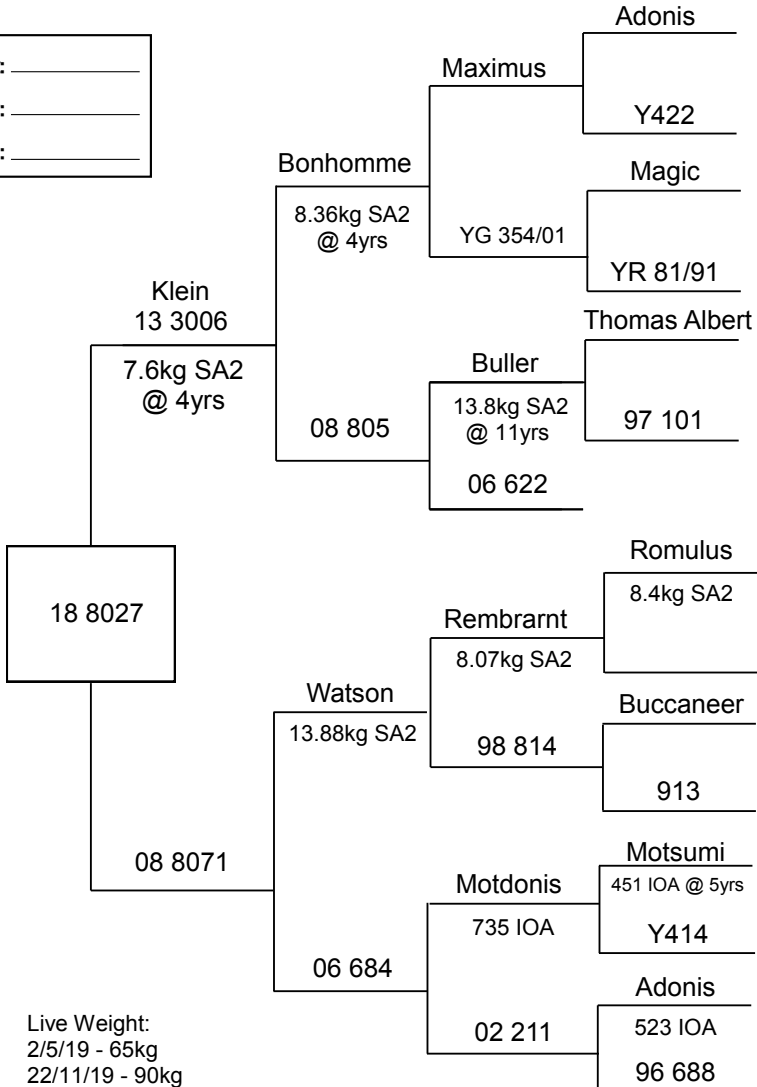

Live Weight:  
 2/5/19 - 65kg  
 22/11/19 - 90kg

Style over weight with Klein over Watson. Granddam 06 684 is a half sister to Motdonis 14.25kg SA. 96 688 features on the bottom line of a 3yr Grafanarkis son cutting over 9kgs this season.



Sale Weight: _____
Purchaser: _____
Price: _____

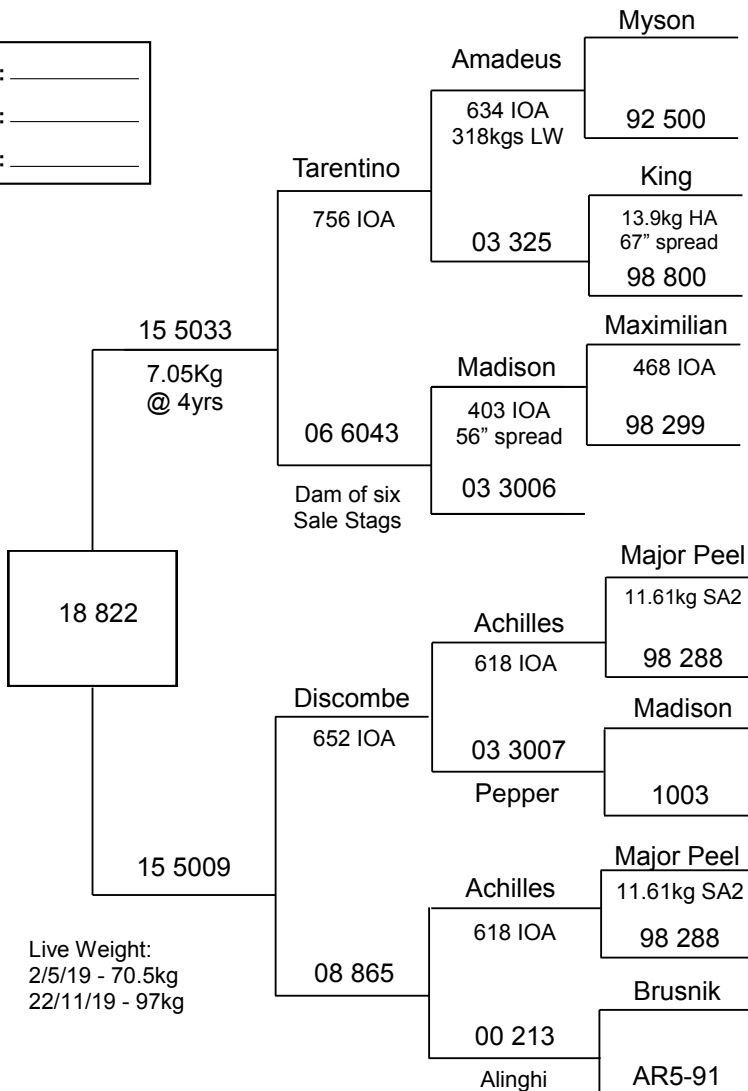

The only offspring from dam 15 5009. The excellent spread and length of sire 15 5033 over two shots of multi points from Discombe and Achilles. Granddam 08 865 is a half sister to Warlord, Spencif and New York.

Lot 44

R1yr Hind 18 871

Sale Weight: \_\_\_\_\_  
 Purchaser: \_\_\_\_\_  
 Price: \_\_\_\_\_

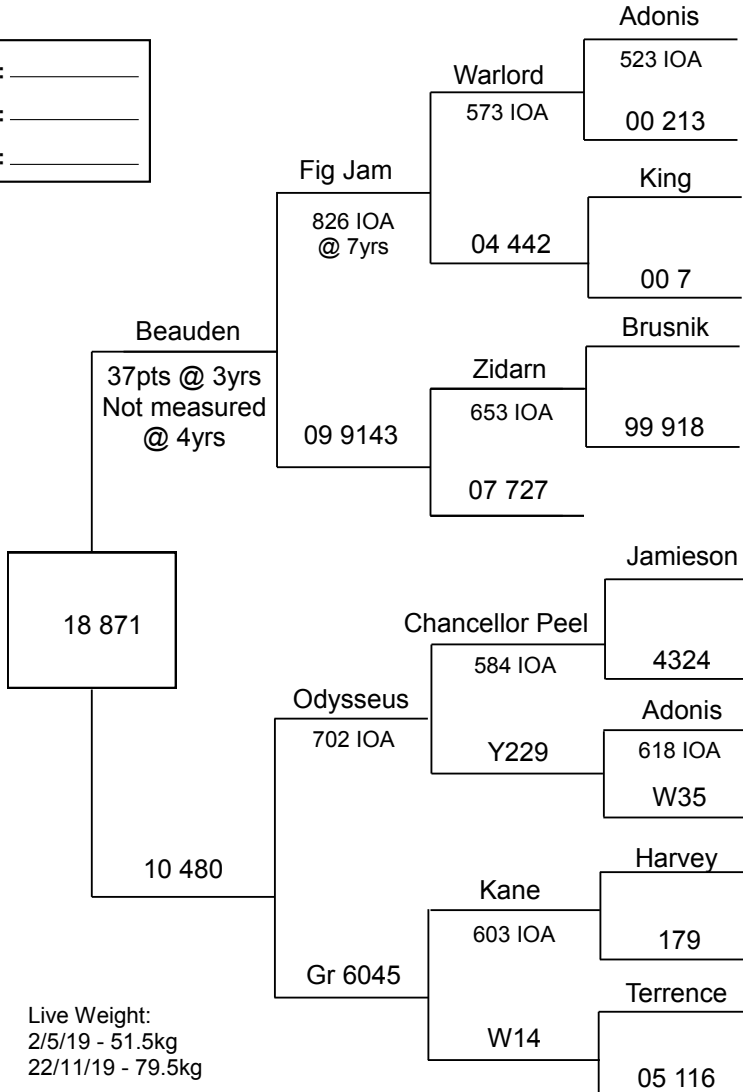

Live Weight:  
 2/5/19 - 51.5kg  
 22/11/19 - 79.5kg

Good combination of width, length and points in this trophy pedigree. Dam 10 480 has produced all daughters since her purchase in 2012.

Sale Weight: _____
Purchaser: _____
Price: _____

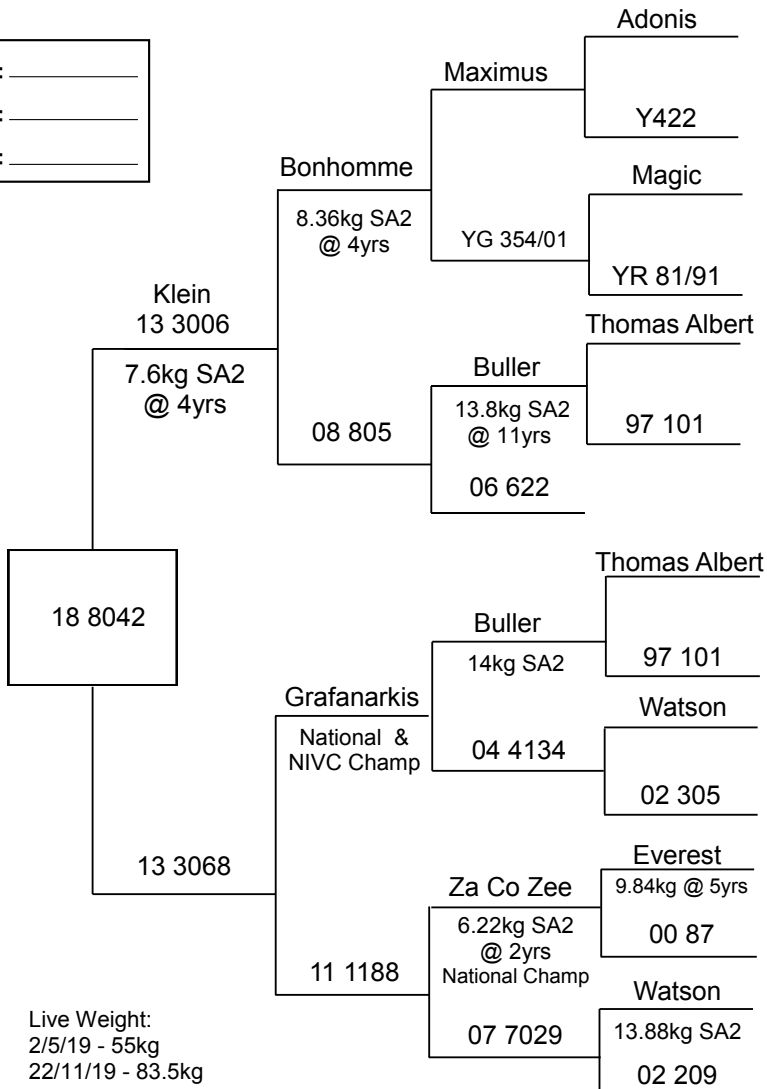

Live Weight:  
2/5/19 - 55kg  
22/11/19 - 83.5kg

This combination of sires including two NZ champs is sure to produce some top progeny. Dam 13 3068 has two daughters and a R3yr son not cut yet. Grandam 11 1188 has six hind offspring.



Lot 46

R1yr Hind 18 8078

Sale Weight: \_\_\_\_\_  
 Purchaser: \_\_\_\_\_  
 Price: \_\_\_\_\_

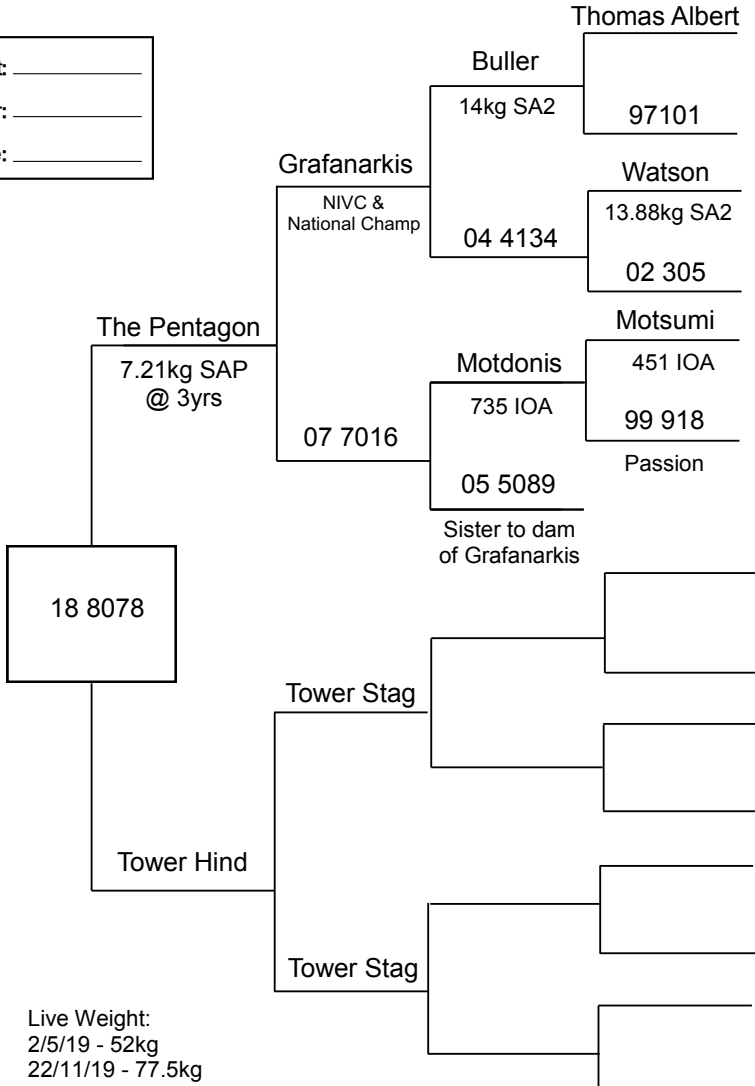

The Pentagon over an unknown Tower Farms hind.

Sale Weight: _____
Purchaser: _____
Price: _____

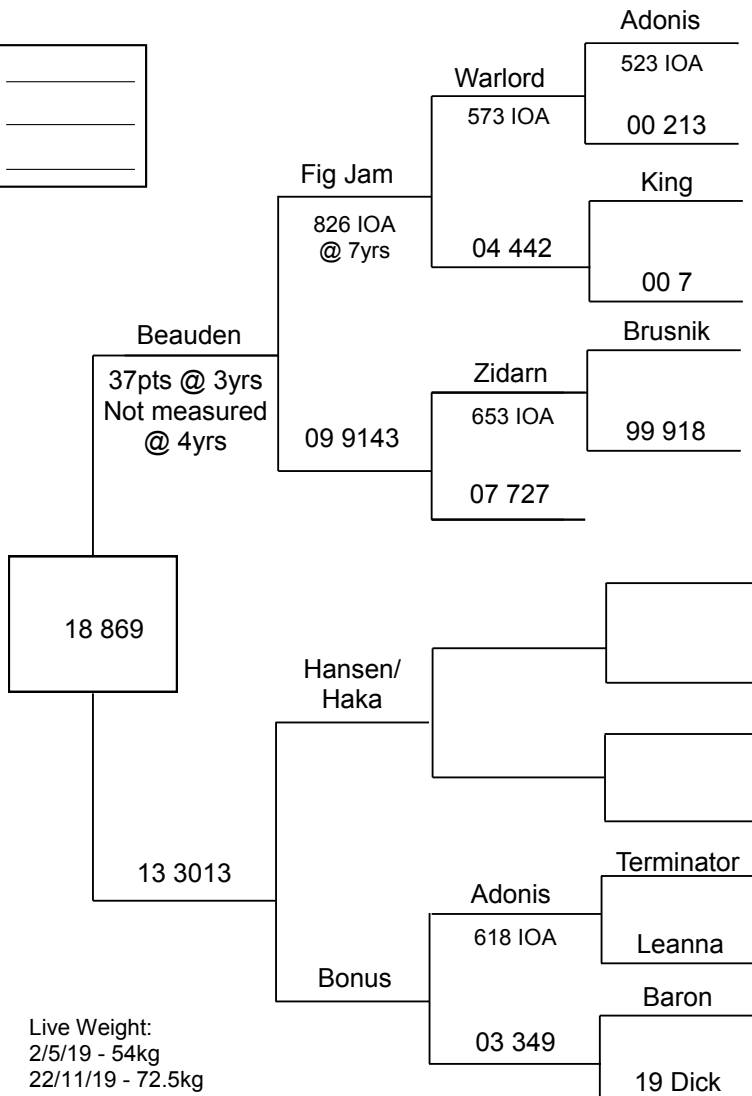

Live Weight:  
2/5/19 - 54kg  
22/11/19 - 72.5kg

Beauden over a half sister to Lot 9 January 2012 \$20,000 by Warlord, rated as probably the best looking 2yr stag to be sold here. Bonus was also the dam of Powerball \$35,000 spiker with 46 points.

**Lot 48**
**R1yr Hind 18 889**

Sale Weight: _____
Purchaser: _____
Price: _____

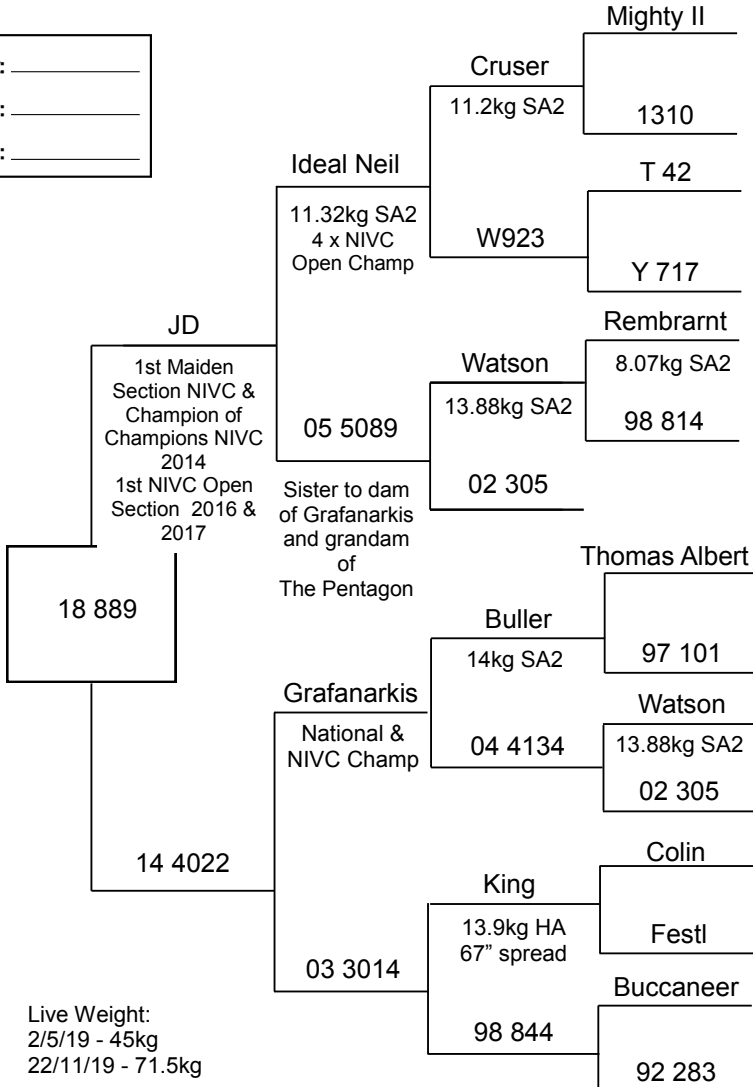

Mouth watering combination of style and weight with JD over a Grafanarkis daughter. 14 4022s only daughter so far. Great granddam 98 844 features in many of our top velvet pedigrees.

Sale Weight: _____
Purchaser: _____
Price: _____

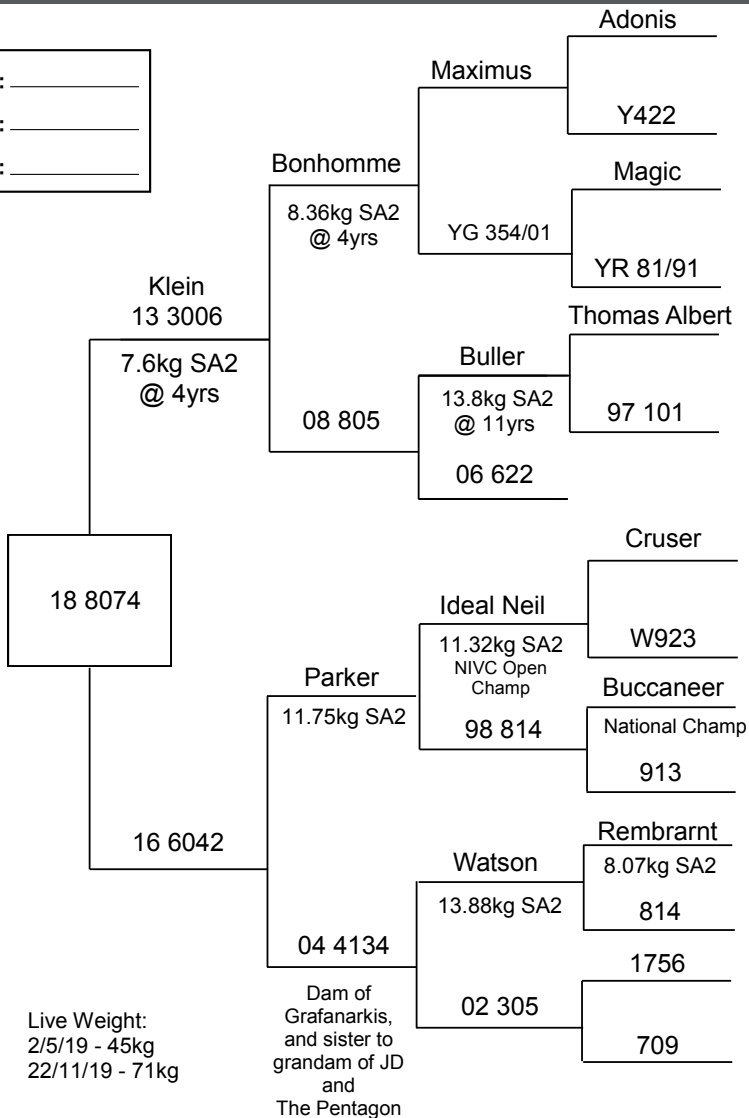

Live Weight:  
2/5/19 - 45kg  
22/11/19 - 71kg

Klein over a first fawning Parker daughter, which is a half sister to our super sire Grafanarkis.

**Lot 50**
**R1yr Hind 18 8002**

Sale Weight: _____
Purchaser: _____
Price: _____

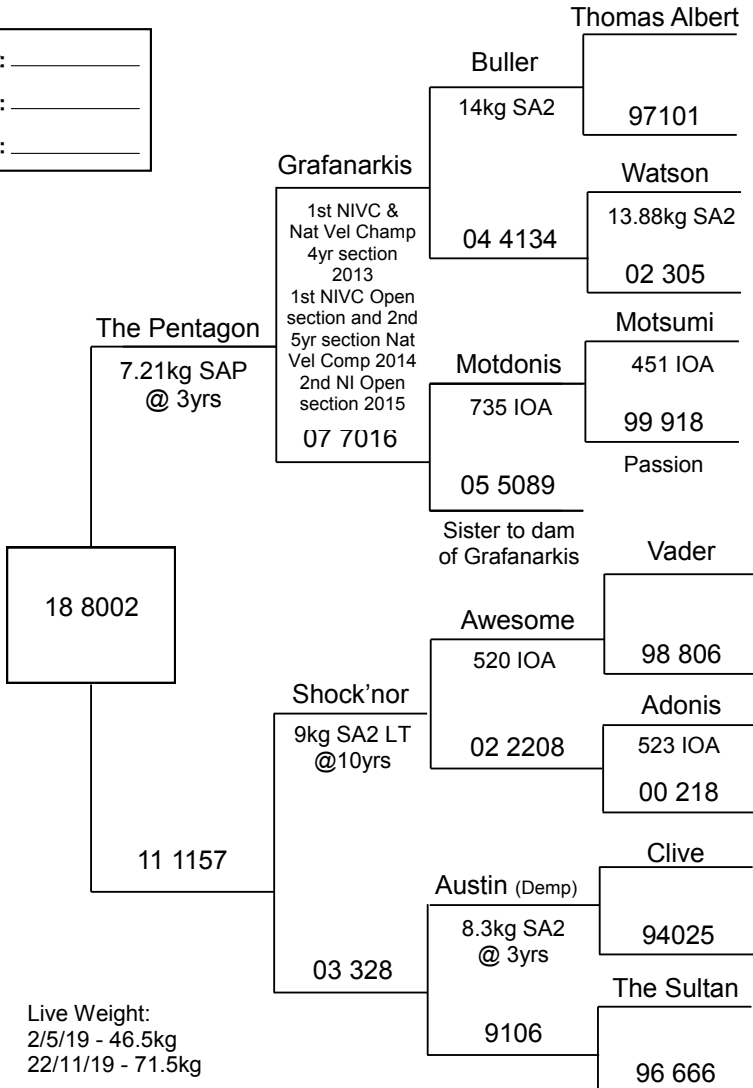

Live Weight:  
2/5/19 - 46.5kg  
22/11/19 - 71.5kg

Strong velvet pedigree which should produce some big velvet. 11 1157s half sister produced \$20,000 son by Buller sold to Raincliff Station. Grandam 03 328s top son sold to Bob Sharp \$14,500 and 9106 is the dam of past sire X Factor.



Sale Weight: _____
Purchaser: _____
Price: _____

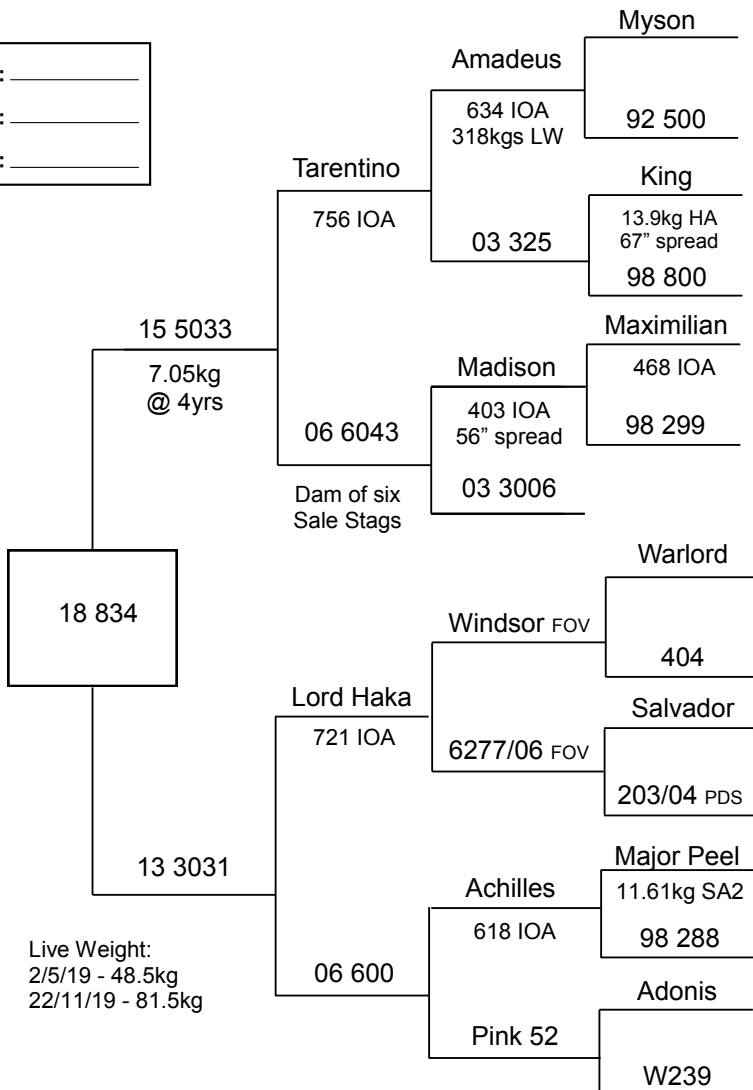

Live Weight:  
2/5/19 - 48.5kg  
22/11/19 - 81.5kg

Sire 15 5033 at 3yrs was used to back up Jefferson in 2018 after he had to be pulled from his mating mob after injuring himself. 15 5033 had an excellent ultra wide attractive clean velvet head and crossed with points from Lord Haka and 06 600, a full sister to the dam of Leon, this should be a genetic recipe for great results.







TOWER FARMS

## **GRAFANARKIS SONS**



**3yr Stag 16 695 - 9.1kg**



**3yr Stag 16 688 - 9.46kg**